

TX-W32R4F Service Manual

Specifications

Parts List

Safety

Block
Diagrams

Service
Information

Schematic
Diagrams

Exploded
View

PCB
Views

Service Support

Service and repair of this product is supported by Panasonic's LUCI interface.

This interface provides a link between the TV and a standard PC to allow a number of diagnostic and control functions to be performed.

For more details contact your local Panasonic company.



BACK

EXIT

Service Manual



TELEVISORE A COLORI

TX-W32R4F

Telaio EURO-4

Specificazione

Alimentazione:	220-240V a.c., 50Hz	INGRESSO AV2	Video (21 pin) 1V p-p 75Ω Audio (21 pin) 500mV rms 10kΩ S-Video IN Y: 1V p-p 75Ω (21-pin) C: 0,3V p-p 75Ω
Consumo:	110W	USCITA AV2	Video (21 pin) 1V p-p 75Ω Audio (21 pin) 500mV rms 1kΩ Uscita selezionabile (21 pin) S-Video IN Y: 1V p-p 75Ω (4-pin) C: 0,3V p-p 75Ω Audio (RCAx2) 500mV rms 10kΩ Video (RCAx1) 1V p-p 75Ω
Impedenza dell'antenna:	75Ω non bilanciata	INGRESSO AV3	
Consumo in Stand-by:	1,8W		
System di Ricezione:	CCIR 625 Linee PAL-I, B/G, H, D/K, PAL-525/60 SECAM L/L', B/G, D/K M.NTSC NTSC (Solo ingresso AV)		
Canali Ricezione:	VHF E2-E12 VHF H1-H2 (ITALY) VHF A-H (ITALY) VHF R1-R2 VHF R3-R5 VHF R6-R12 UHF E21-E69 CATV (S01-S05) CATV S1-S10 (M1-M10) CATV S11-S20 (U1-U10) CATV S21-S41 (HYPER)	Tensione all'anodo:	30,5kV ± 1kV
Frequenze Intermedie:	Video 38,9MHz, 34MHz Sound 32,9MHz, 33,4MHz, 33,16MHz 32,4MHz, 40,4MHz, 33,05MHz 32,66MHz	Tubo Catodico:	W76LFC185X06 76cm
Colore	34,47MHz (PAL) 34,5MHz, 34,65MHz (SECAM)	Potenza Audio:	2 x 20W (Musicali) 8Ω Impedenza
Prese Video/Audio:		Cuffia:	8Ω Impedenza
USCITA AUDIO MONITOR	Audio (RCAx2) 500mV rms 1kΩ	Accessori:	Telecomando 2 x R6 (UM3) Batterie
INGRESSO AV1	Video (21 pin) 1V p-p 75Ω Audio (21 pin) 500mV rms 10kΩ RVB (21 pin)	Dimensioni:	
USCITA AV1	Video (21 pin) 1V p-p 75Ω Audio (21 pin) 500mV rms 1kΩ	Altezza:	555mm
		Larghezza:	862mm
		Profondità:	553mm
		Peso netto:	50Kg
		Le caratteristiche possono variare senza preavviso. Peso e dimensioni sono approssimate.	
		NOTA: Per maggiori informazioni consultare la guida tecnica del telaio EURO-4.	

Indice

Norme di sicurezza.....	2
Consigli per l'assistenza.....	3
Procedura di Taratura.....	4
Forma D'onda.....	5
Valori di allineamento.....	6
Schema a blocchi.....	7
Ubicazione Dei Componenti.....	11
Elenco Parti Di Ricambio.....	12
Schema Elettrico.....	22
Vista Lato Componenti.....	26

Norme di sicurezza

Precauzioni

1. E'Consigliabile utilizzare un trasformatore di isolamento prima di eseguire ogni intervento sul telaio.
 2. Durante l'assistenza, verificare lo stato dei conduttori specialmente nei circuiti ad alta tensione. In caso di corto circuito, sostituire tutti le parti surriscaldate o danneggiate.
 3. Dopo l'assistenza, assicurarsi che tutti gli accorgimenti di protezione (isolatori, schermi, isolatore R-C, ecc) siano correttamente installati.
 4. Quando il televisore non viene utilizzato per lunghi periodi, scollegarlo dalla rete.
 5. Alta tensione 31,5kV è presente quando il televisore è in funzione. Utilizzare il televisore senza il pannello posteriore comporta il pericolo di scosse elettriche dai circuiti di alimentazione. L'assistenza deve essere eseguita solo da personale specializzato a conoscenza delle necessarie precauzioni da adottare. Prima di intervenire sul cinescopio, scaricare a massa l'anodo dello stesso.
 6. Dopo l'assistenza assicurarsi di eseguire le seguenti prove di dispersione per prevenire rischi di scossa elettrica all'utente.
3. Utilizzare un voltmetro a.c. con sensibilità 1000Ω/Volt o più per misurare il potenziale ai capi della resistenza.
 4. Verificare ogni parte metallica esterna misurando la tensione ogni volta.
 5. Invertire la presa a.c. di alimentazione e ripetere le misure precedenti.
 6. Il potenziale in ogni punto non deve superare 1,4V rms, in caso superi questo valore, c'è pericolo di scossa elettrica e il televisore deve essere riparato e controllata prima di essere riconsegnato al proprietario.

Controllo a freddo di dispersione

1. Disinserire il cavo di alimentazione e corto circuitare i due terminali.
2. Azionare l'interruttore di accensione.
3. Collegare uno strumento per la misure di resistenza con segue un puntale sulla spina del cavo di alimentazione e l'altro sul telaio del televisore o su una parte metallica (ad esempio viti) collegate telaio. Se la parte metallica ha un collegamento col telaio la lettura dovrà essere compresa tra i valori 4MΩ e 20MΩ, se la parte metallica non ha un collegamento con il telaio la lettura dovrà essere.

Controllo a caldo di dispersione

1. Inserire la spina nella presa di corrente. Non usare un trasformatore di isolamento per questo controllo.
2. Collegare una resistenza da 2kΩ 10W in serie con una parte metallica esterna del televisore e con un punto di terra (esempio: tubi dell'acqua).

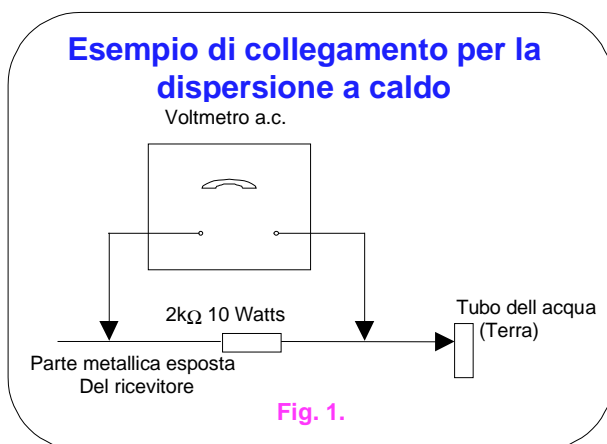

Radiazioni raggi X

Precauzioni:

1. La sezione ad alta tensione e il cinescopio sono sorgenti di raggi X.
2. In caso di utilizzo di una sonda per alta tensione, assicurarsi che la stessa sopporti 31,5kV senza pericolo di emissione di raggi.

NOTA: E'importante verificare periodicamente la funzionalità del misuratore di tensione.

1. Regolare la luminosità al minimo.
2. Misurare l'alta tensione. La lettura dovrà essere 30,5kV ± 1kV. (se è necessario un immediato intervento tecnico per prevenire danni.)
3. Per prevenire la possibilità di emissione di raggi X, è indispensabile utilizzare il cinescopio specificato.

Consigli per l'assistenza

Come rimuovere il pannello posteriore

1. Rimuovere le 10 viti (A) come indicato in Fig.2.

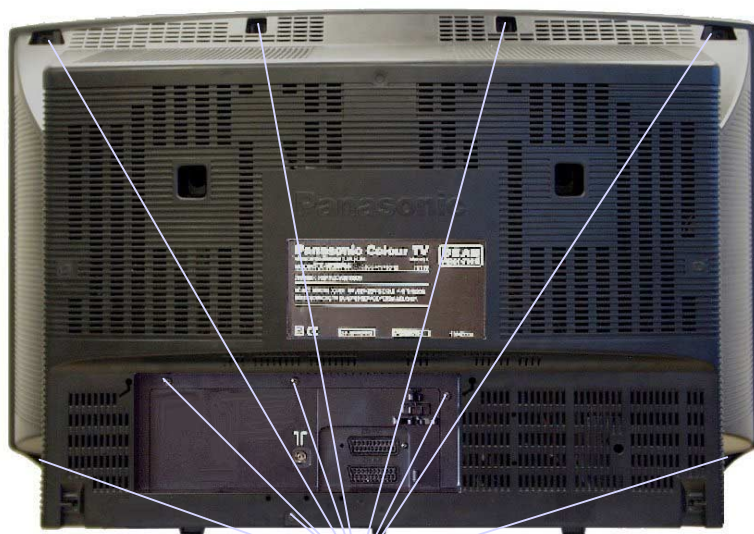

Viti A
Fig.2.

Ubicazione dei Controlli

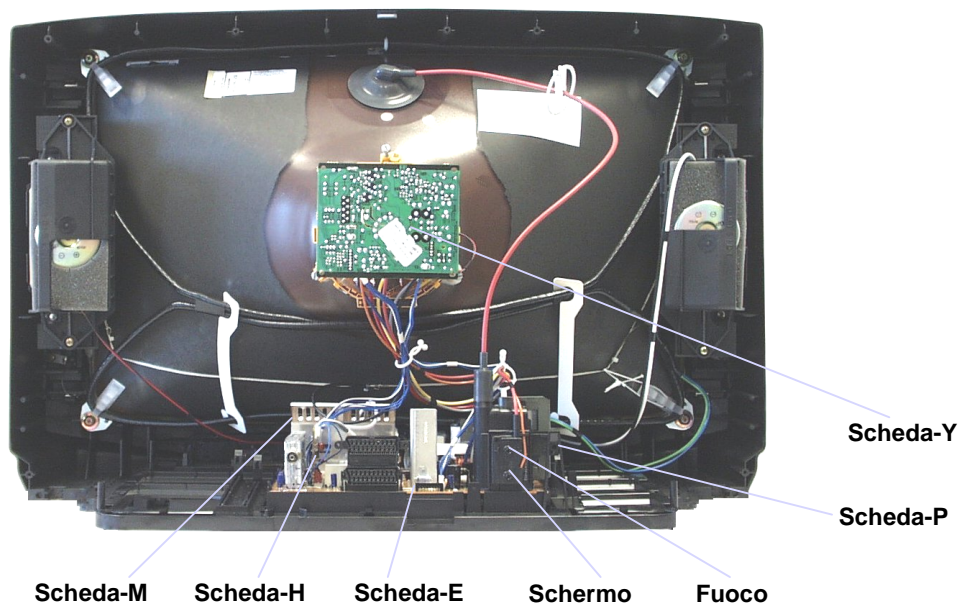

Fig.3.

Procedura di taratura

TARATURE/PREPARAZIONE	REGOLAZIONE												
REGOLAZIONE +B 1. Ricevere un segnale a barre colori. 2. Predisporre I controlli :- Luminosita' minimo Contrasto minimo Volume minimo	1. Con il trimmer R811 regolare la tensione B2 per $148V \pm 1V$. 2. Confermare le seguenti alimentazioni <table style="width: 100%; border: none;"> <tr> <td>B9 5 ± 0,25V</td> <td>B10 5 ± 0,25V</td> </tr> <tr> <td>B5 12 ± 0,5V</td> <td>B11 33 ± 1,5V</td> </tr> <tr> <td>B4 16 ± 1V</td> <td>B7 8 ± 0,5V</td> </tr> <tr> <td>B12 26 ± 1V</td> <td>B8 5,5 ± 0,5V</td> </tr> <tr> <td>B3 41 ± 1V</td> <td>B13 15 ± 1V</td> </tr> <tr> <td>B1 200 ± 10V</td> <td>B14 -15 ± 1V</td> </tr> </table>	B9 5 ± 0,25V	B10 5 ± 0,25V	B5 12 ± 0,5V	B11 33 ± 1,5V	B4 16 ± 1V	B7 8 ± 0,5V	B12 26 ± 1V	B8 5,5 ± 0,5V	B3 41 ± 1V	B13 15 ± 1V	B1 200 ± 10V	B14 -15 ± 1V
B9 5 ± 0,25V	B10 5 ± 0,25V												
B5 12 ± 0,5V	B11 33 ± 1,5V												
B4 16 ± 1V	B7 8 ± 0,5V												
B12 26 ± 1V	B8 5,5 ± 0,5V												
B3 41 ± 1V	B13 15 ± 1V												
B1 200 ± 10V	B14 -15 ± 1V												
CUT OFF / Ug2 Test 1. Ricevere un segnale a barre colori. 2. Smagnetizzare il cinescopio esternamente. 3. Entrare nel SERVICE Mode 1. 4. Selezionare CUT-OFF .	Per regolare il cutoff collegare la sonda sul blu, e regolare con il tasto giallo o blu per 160 V, premere STR . Selezionare Ug2 e regolare la VR per visualizzare O.K..												

SELF CHECK (auto diagnosi)

Il SELF CHECK é usato per testare le linee "BUS" ed il codice esadecimale del TV. Per richiamare il SELF-CHECK occorre premere il tasto di "**STATUS**" sul telecomando e contemporaneamente il tasto (-) sul TV. Attenzione: quando si richiama il Self-check, il TV verrà resettato ritornando alle condizioni di fabbrica, cancellando I canali sintonizzati dal cliente. Sullo schermo apparirà la seguente in tabella :

VDP	O.K.	PCB	O.K.
TUN	O.K.	CAB	O.K.
E2	O.K.	Sum	Solo per la fabbrica
MSP	O.K.		
DPL	--		
OPTION 1	39		
OPTION 2	7D		
OPTION 3	3F		
OPTION 4	00		
OPTION 5	FF		
OPTION 6	25		

Se uno degli ingressi/uscite della "CPU" e' riconosciuta come incorretta, sullo schermo apparira' "--" invece di "OK".

Materiale di supporto per l'assistenza TV.

- **LUCI** interface kit (Linked Utility Computer Interface)
 Il kit contiene l'interfaccia, I cavi per la connessione al TV e al PC, il software per il diagnostico.
 Ogni volta che verrà introdotta una nuova gamma di modelli sarà disponibile il nuovo software aggiornato.
- **VICI** (Visual Interactive Computer Information)
 Questi C.D. rom contengono le seguenti informazioni:
 1. Service Manual
 2. Libretti di istruzioni (anche in lingua italiana)
 3. Informazioni tecniche
- **TASMIN** (Technically Advanced System for Multimedia Interactive Notes)
 Rappresenta il primo passo per avere informazioni tecniche più velocemente ed in modo interattivo.

FORMA D'ONDA

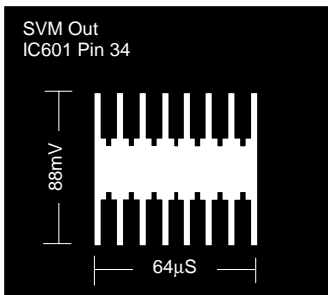
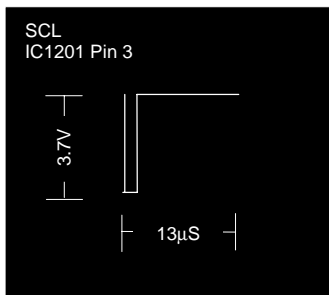
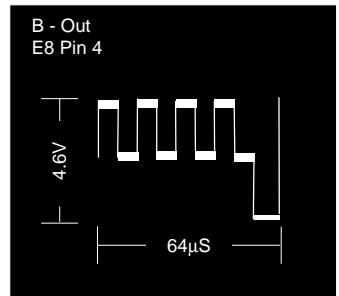
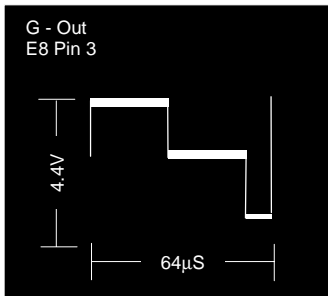
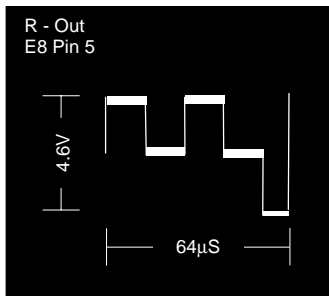
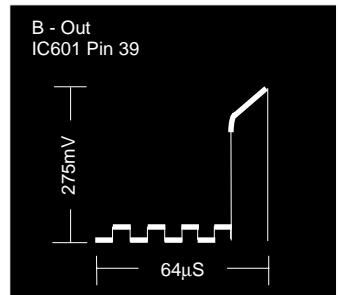
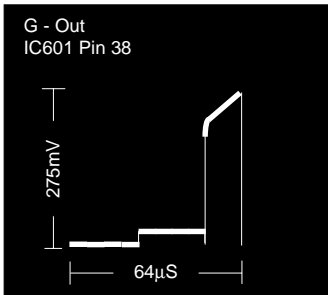
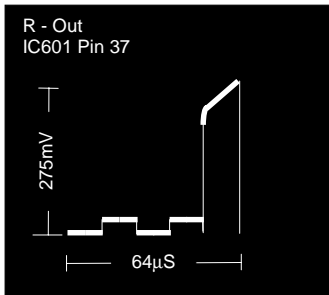
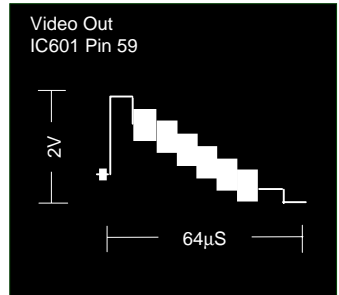
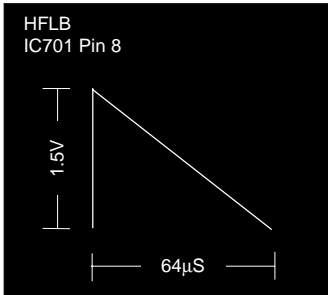
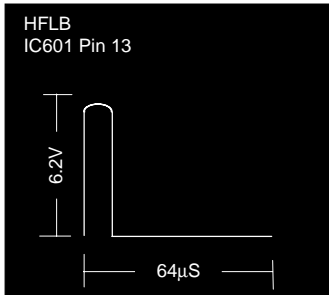
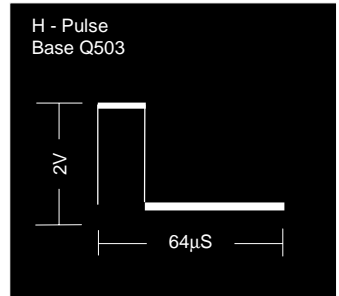
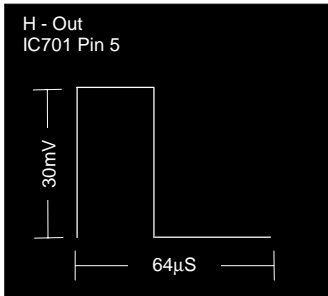
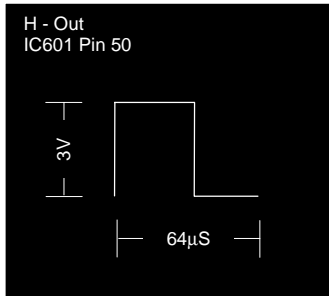
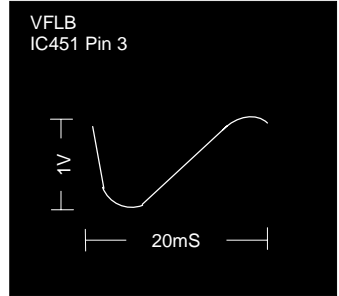
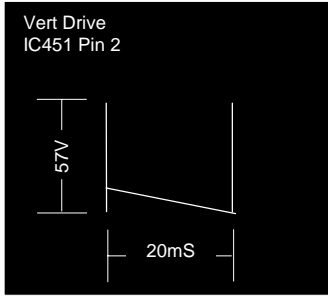
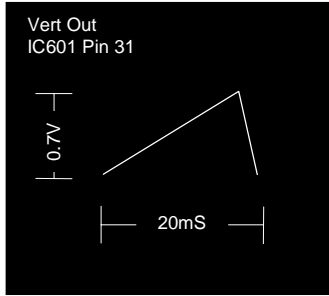

Valori di allineamento, esempi:

(N.B. I valori indicati sullo schermo sono approssimative.)

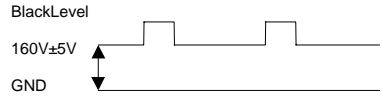
Funzione	Valori indicativi	Impostazioni
Posizione orizz	H-Pos 061	Posizione ottimale.
V-Pos	V-Pos 005	Posizione ottimale.
Ampiezza orriz	H-Amp 055	Posizione ottimale.
Ampiezza vert	V-Amp 054	Posizione ottimale.
EO-ampiezza	EW-Amp 1 -128	Posizione ottimale.
EO-ampiezza	E/W-Amp 2 006	Posizione ottimale.
Correz-trapezoidale	Trapez-1 047	Posizione ottimale.
Correz-trapezoidale	Trapez-2 -128	Posizione ottimale.
Linearita vert	V-Lin 006	Posizione ottimale.
Simmetria verticale	V-Sym 002	Posizione ottimale.
DVCO	DVCO -005	Premere il tasto blu , poi STR .
Cutoff	Cut-off 0171	<p>Per regolare il cutoff collegare la sonda sul blu, e regolare con il tasto giallo o blu per 160V, premere STR. Selezionare Ug2 e regolare la VR per visualizzare ok.</p> 
Ug2 Test	Ug2 055 O.K.	
Highlight Lowlight	High 0902 0777 0864 Low 0117 0132 0112	Posizione ottimale.
Sub-Brightness	Sub-Brightness 255	Posizione ottimale.

SCHEMA A BLOCCHI SEGNALI VIDEO

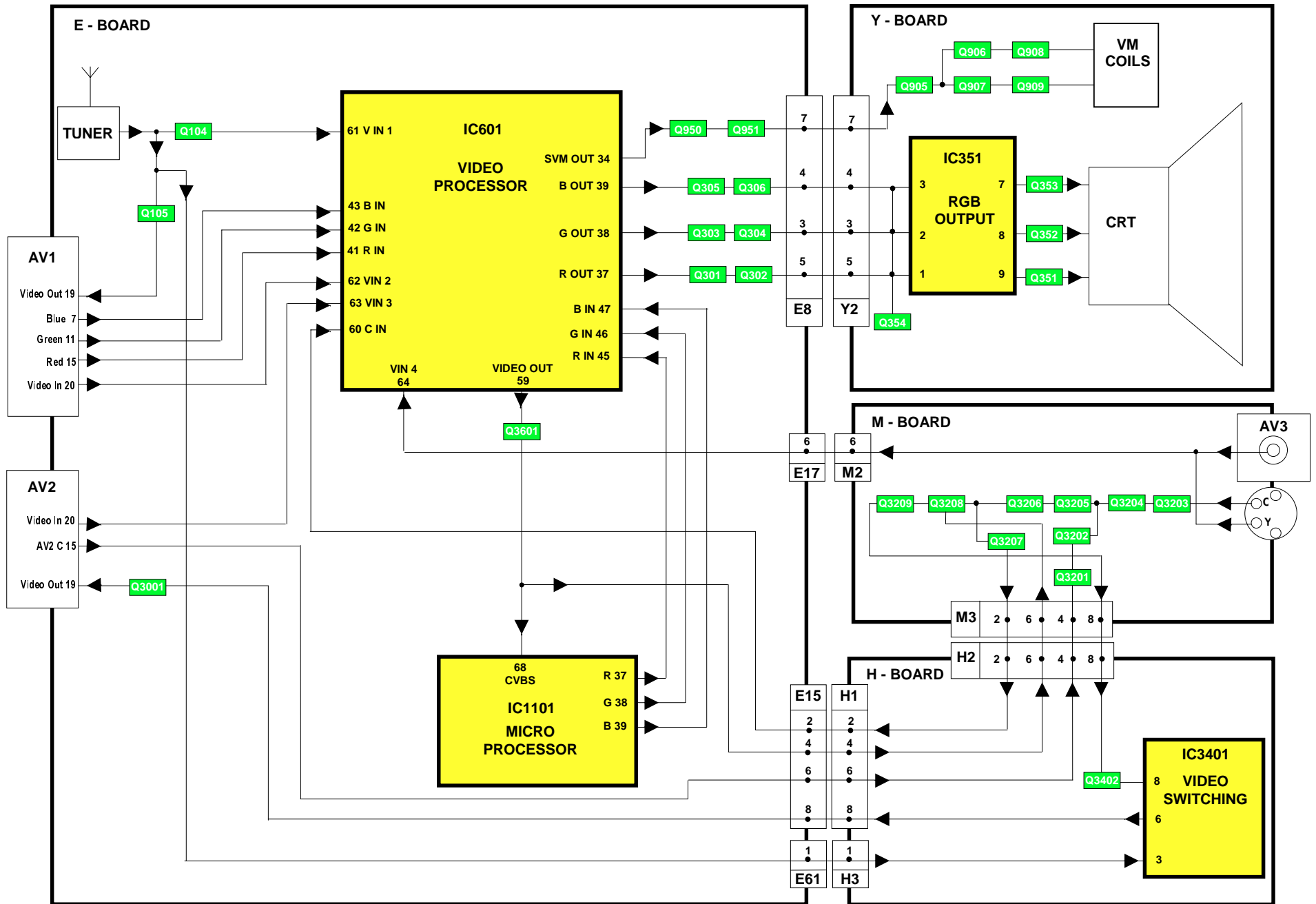

SCHEMA A BLOCCHI SEGNALI AUDIO

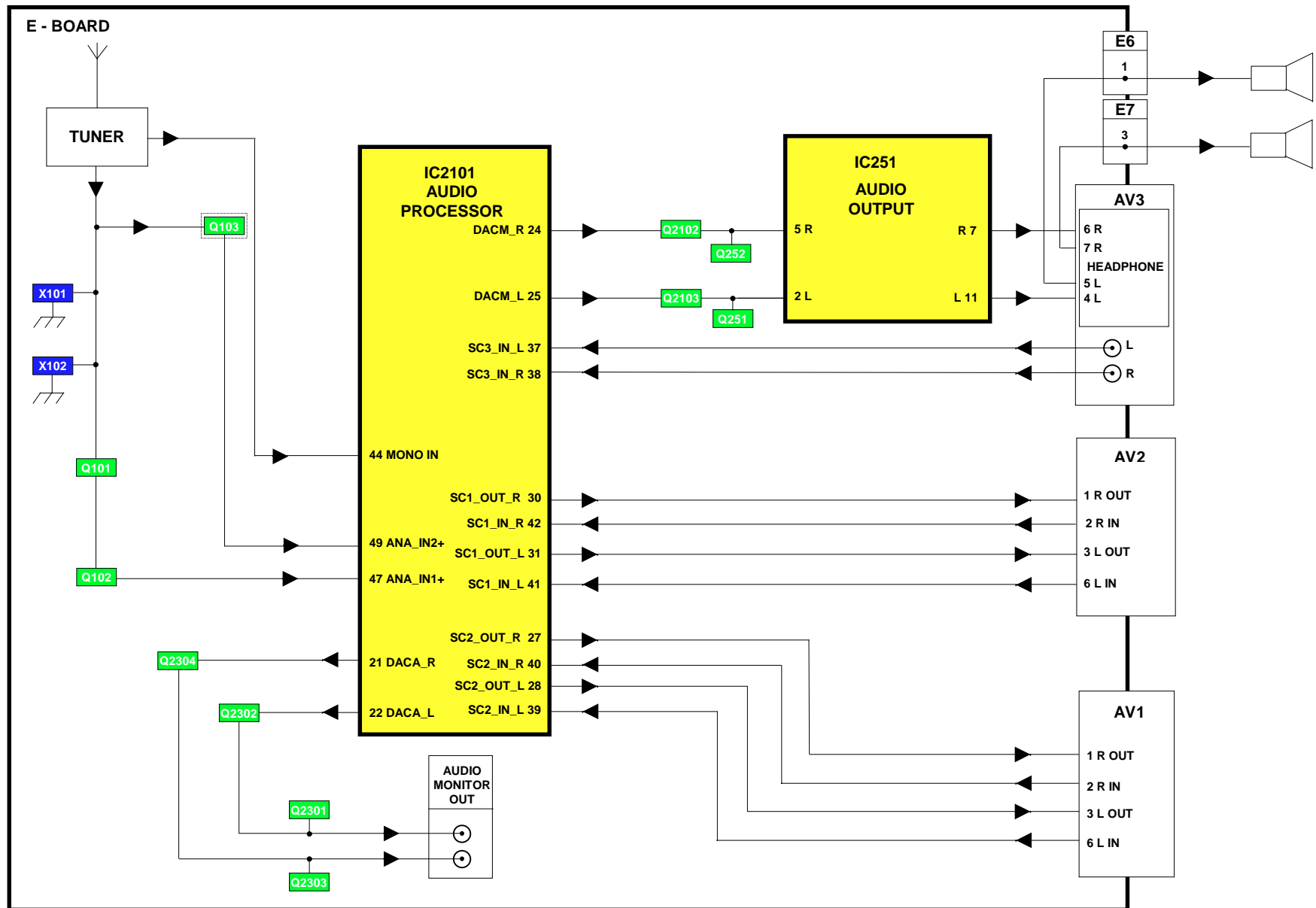

SCHEMA A BLOCCHI LINEE DI CONTROLLO

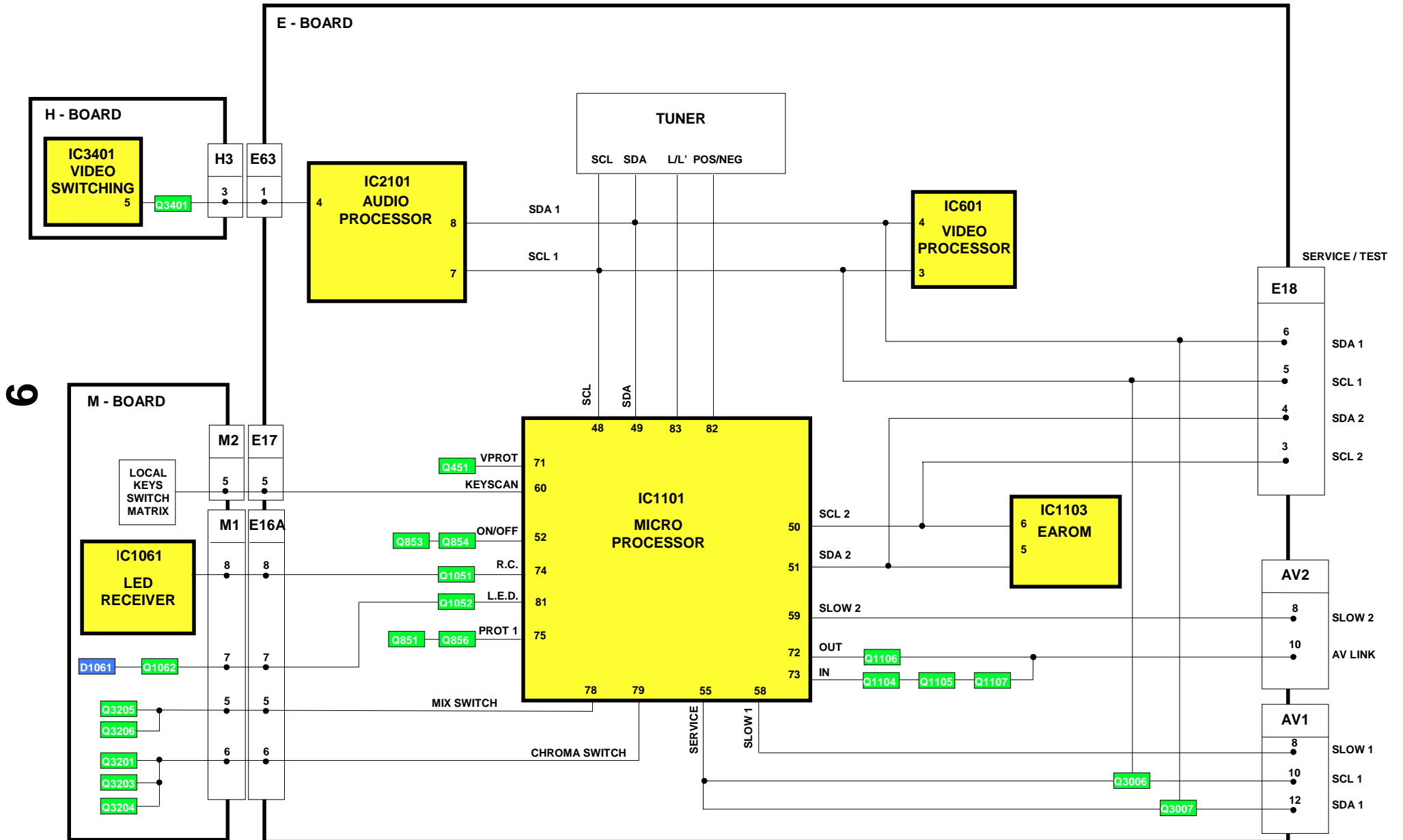

SCHEMA A BLOCCHI POTENZA ALIMENTAZIONE

10

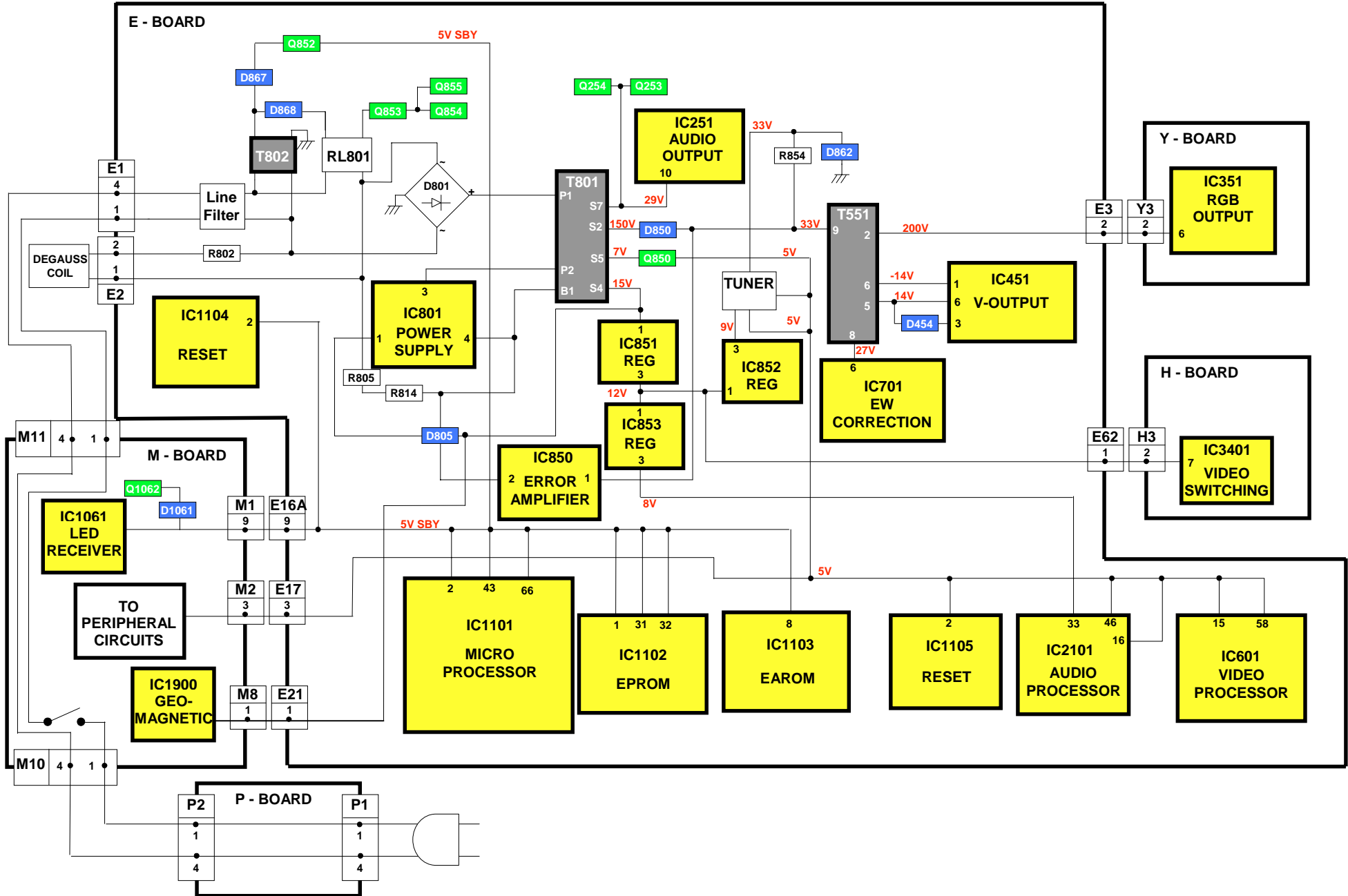

UBICAZIONE DEI COMPONENTI

NOTA:

In questa pagina numeri all' interno di un cerchio corrispondono ai numeri riportanti nell'elenco parti di ricambio.

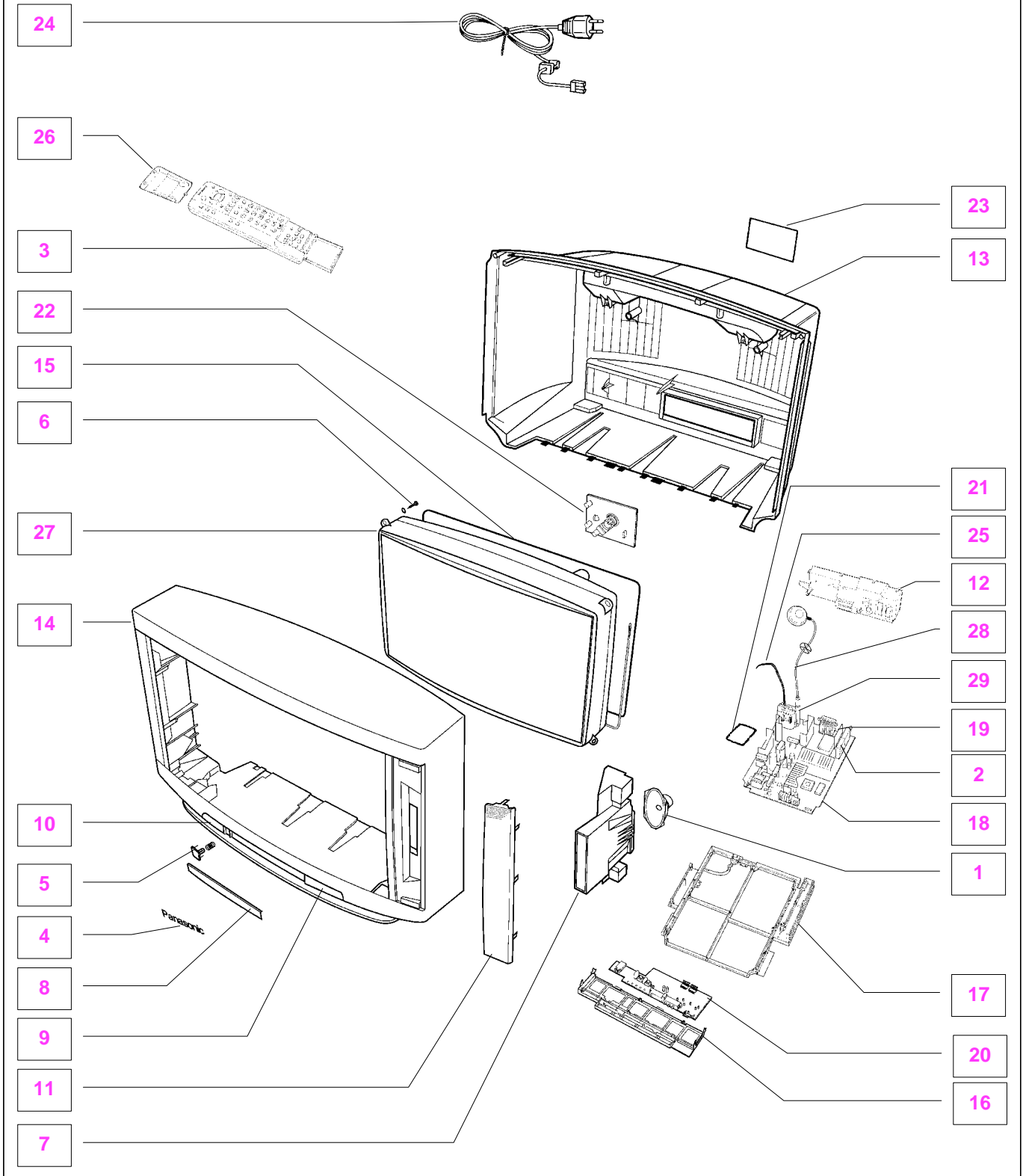





















ELENCO PARTI DI RICAMBIO

Nota

Componenti contrassegnati  sono di sicurezza e devono essere sostituiti solo con quelli specificati.

* Quando ordinate questi ricambi, dovete assolutamente sempre riportare il modello esatto e completo del TV riportato nell'etichetta posteriore del televisore.

Cct Ref	Parts Number	Description
MECHANICAL PARTS		
1	EAGG1218J2	SPEAKER
2	ENG29505G	TUNER 
3	EUR511210	REMOTE CONTROL
4	TBM8E1728	PANASONIC BADGE
5	TBX8E049	POWER BUTTON
6	THT1062	CRT FIXING SCREW
7	TKK8E026	SPEAKER REFLECTOR
8	TKP8E1141	DOOR LID
9	TKP8E1142	RIGHT PANEL
10	TKP8E1143	LEFT PANEL
11	TKP8E1148	SPEAKER NET
12	TKP8E1254	AV PANEL
13	TKU8E00290	BACK COVER 
14	TKY8E110	CABINET 
15	TLK8E05123	DEGAUSS COIL 
16	TMW8E023	CONTROL BRACKET
17	TMX8E031	CHASSIS FRAME
18	TNP8EE009BZ	E P.C.B. 
19	TNP8EH002AB	H P.C.B. 
20	TNP8EM017AA	M P.C.B. 
21	TNP8EP015AA	P P.C.B. 
22	TNP8EY012AH	Y P.C.B. 
23	TQF8E2743	MODEL LABEL 
24	TSX8E0027	POWER CORD 
25	TXFJTF01BMTG	FOCUS LEAD ASSY
26	UR51EC904A	BATTERY COVER (REMOTE)
27	W76LFC185X06	C.R.T. 
28	ZTBZAD550A	ANODE CABLE
29	ZTFM05002A	F.B.T. 
MISCELLANEOUS COMPONENTS		
	31221212478	FIX CLIP
	F9-4-220	RELAY
	PLCC-84-T	84 PIN IC SOCKET
	TBM8E1532-2	PRESET PANEL
	TBM8E1886	REAR AV LABEL
	TEK6940	LID CATCH
	TLK8E05124	GEOMAGNETIC COIL 
	TMW8E017	LED HOLDER
	TPC8E4729	OUTER CARTON
	TPD8E621	TOP CUSHION
	TPD8E622	BOTTOM CUSHION
	UM-3DJ-2P	BATTERY PACK
RL801	TSE1885-1	RELAY
R802	232266296706	THERMISTOR 
S351	0330550049	C.R.T. SOCKET
INSTRUCTION BOOKS		
	TQB8E2569A-3	GERMAN 
	TQB8E2569BD2	DUTCH/FRENCH 
	TQB8E2569CE3	ITALIAN/SPANISH 
	TQB8E2569FG2	SWEDISH/NORG. 
	TQB8E2569HK2	SUOMI/DANISH 

Cct Ref	Parts Number	Description
I.C.s		
IC251	LA4282	AUDIO OUTPUT
IC351	TDA6103Q-N3	R.G.B. OUTPUT
IC451	LA7845N	VERTICAL OUTPUT
IC601	VDP3120BPPB1	VIDEO PROCESSOR
IC701	TEA2031A	E/W CORRECTION
IC801	STRF6654LF51	POWER SUPPLY
IC850	SE140N	ERROR AMPLIFER
IC851	L78M12MRB	12V REGULATOR
IC852	L78M09MRB	9V REGULATOR
IC853	AN78L08TA	8V REGULATOR
IC1061	RPM-637CBRS1	LED RECEIVER
IC1101	SDA5450C48	MICRO PROCESSOR
IC1102	27C2001-F26	EPROM *
IC1103	XGL2-03SF	EAROM *
IC1104	MN1381-R(TA)	RESET
IC1105	MN1381-T(TA)	RESET
IC1900	LA6515	EARTH CORRECTION
IC2101	MSP3410DPOB4	AUDIO PROCESSOR
IC3401	TEA2114	VIDEO SWITCHING
FUSES		
F801	19181-3.15	FUSE 
F8011	EYF52BC	FUSE HOLDER
F8012	EYF52BC	FUSE HOLDER
DIODES		
D101	MA3020TX	DIODE
D102	MA3020TX	DIODE
D251	MA2180BLFS	DIODE
D253	MA700TA5	DIODE
D254	MA700TA5	DIODE
D354	1SR124-4AT82	DIODE
D355	1SR124-4AT82	DIODE
D356	1SR124-4AT82	DIODE
D357	MA165TA5	DIODE
D358	MA165TA5	DIODE
D359	MA165TA5	DIODE
D360	MTZJT-7715A	DIODE
D361	MA165TA5	DIODE
D362	MA165TA5	DIODE
D363	MA165TA5	DIODE
D364	MA165TA5	DIODE
D453	MA165TA5	DIODE
D454	ERA15-02V3	DIODE
D456	MTZJT-775.6C	DIODE
D457	MA165TA5	DIODE
D501	MA165TA5	DIODE
D502	1SR124-4AT82	DIODE
D511	MA4047	DIODE
D552	RU3LFA1	DIODE
D553	1SR124-4AT82	DIODE
D554	1SR124-4AT82	DIODE
D556	MA165TA5	DIODE

Cct Ref	Parts Number	Description
D557	EU02	DIODE
D558	1SR124-4AT82	DIODE
D580	ERD07-15L7	DIODE
D601	DAN217T146	DIODE
D603	DAN217T146	DIODE
D605	DAN212KT146	DIODE
D606	MA165TA5	DIODE
D607	MA4051	DIODE
D609	1SR124-4AT82	DIODE
D615	STZ6.2NT146	DIODE
D616	STZ6.2NT146	DIODE
D701	MA165TA5	DIODE
D702	MTZJT-775.1C	DIODE
D704	MA29TA5	DIODE
D705	MTZJT-775.6C	DIODE
D801	RBV-608LF-B	DIODE
D803	1SR124-4AT82	DIODE
D804	1SR124-4AT82	DIODE
D805	TLP621GR-LF2	PHOTO COUPLER
D806	1SR124-4AT82	DIODE
D850	RU4BLF-L1	DIODE
D851	MTZJT776.2B	DIODE
D852	MA165TA5	DIODE
D853	MA2180BLFS	DIODE
D854	TVSRU2AMLFA5	DIODE
D855	FML22SLF610	DIODE
D856	RU4AMLF-M1	DIODE
D857	MTZJT-775.1C	DIODE
D858	MA165TA5	DIODE
D859	MA165TA5	DIODE
D860	MA165TA5	DIODE
D861	MA165TA5	DIODE
D862	MTZJT-7736A	DIODE
D863	MA165TA5	DIODE
D864	MA165TA5	DIODE
D865	MA165TA5	DIODE
D866	MA165TA5	DIODE
D867	EK06-V0	DIODE
D868	1N4150T-77	DIODE
D869	1N4150T-77	DIODE
D870	MA165TA5	DIODE
D871	1N4150T-77	DIODE
D873	MTZJT-775.6C	DIODE
D874	1SR124-4AT82	DIODE
D875	BZX79A75A26A	DIODE
D901	MA165TA5	DIODE
D902	MA165TA5	DIODE
D904	MA165TA5	DIODE
D905	MA165TA5	DIODE
D906	RLS72TE-11	DIODE
D1061	LN81RPHL	DIODE
D1101	MA165TA5	DIODE
D1102	MA165TA5	DIODE
D1104	MA165TA5	DIODE
D1105	MA165TA5	DIODE
D2101	MA723TA5	DIODE
D2102	MA723TA5	DIODE
D2103	MA723TA5	DIODE
D2104	MA723TA5	DIODE
D2105	MTZJT-778.2C	DIODE
D2303	MA723TA5	DIODE
D2304	MA723TA5	DIODE
D3201	MTZJT-778.2C	DIODE
D3202	MTZJT-778.2C	DIODE
TRANSISTORS		
Q101	BC847B	TRANSISTOR

Cct Ref	Parts Number	Description
Q102	BC847B	TRANSISTOR
Q103	BC847B	TRANSISTOR
Q104	BC847B	TRANSISTOR
Q105	BC847B	TRANSISTOR
Q251	2SD1328STX	TRANSISTOR
Q252	2SD1328STX	TRANSISTOR
Q253	BC847B	TRANSISTOR
Q254	BC847B	TRANSISTOR
Q301	BC847B	TRANSISTOR
Q302	FMY4T148	TRANSISTOR
Q303	BC847B	TRANSISTOR
Q304	FMY4T148	TRANSISTOR
Q305	BC847B	TRANSISTOR
Q306	FMY4T148	TRANSISTOR
Q351	2SA1767	TRANSISTOR
Q352	2SA1767	TRANSISTOR
Q353	2SA1767	TRANSISTOR
Q354	BC857B	TRANSISTOR
Q451	BC857B	TRANSISTOR
Q503	2SD2398-M2	TRANSISTOR
Q551	2SD1577LB	TRANSISTOR
Q552	2SC1473-RN	TRANSISTOR
Q701	BC857B	TRANSISTOR
Q850	2SD1273PLB	TRANSISTOR
Q851	BC857B	TRANSISTOR
Q852	2SC1383-S	TRANSISTOR
Q853	BC847B	TRANSISTOR
Q854	BC847B	TRANSISTOR
Q855	BC847B	TRANSISTOR
Q856	BC847B	TRANSISTOR
Q857	2SA1018QTA	TRANSISTOR
Q905	BC847B	TRANSISTOR
Q906	BC847B	TRANSISTOR
Q907	BC857B	TRANSISTOR
Q908	2SA1535ARLB	TRANSISTOR
Q909	2SC3944ARLB	TRANSISTOR
Q950	BC847B	TRANSISTOR
Q951	FMY4T148	TRANSISTOR
Q1051	BC847B	TRANSISTOR
Q1062	BC847B	TRANSISTOR
Q1101	BC847B	TRANSISTOR
Q1104	BC847B	TRANSISTOR
Q1105	BC847B	TRANSISTOR
Q1106	BC847B	TRANSISTOR
Q1107	BC847B	TRANSISTOR
Q1108	BC847B	TRANSISTOR
Q2101	BC857B	TRANSISTOR
Q2102	BC857B	TRANSISTOR
Q2103	BC857B	TRANSISTOR
Q2301	BC847B	TRANSISTOR
Q2302	BC857B	TRANSISTOR
Q2303	BC847B	TRANSISTOR
Q2304	BC857B	TRANSISTOR
Q3001	BC847B	TRANSISTOR
Q3006	BC847B	TRANSISTOR
Q3007	BC847B	TRANSISTOR
Q3201	BC847B	TRANSISTOR
Q3202	BC847B	TRANSISTOR
Q3203	BC857B	TRANSISTOR
Q3204	BC857B	TRANSISTOR
Q3205	BC847B	TRANSISTOR
Q3206	BC847B	TRANSISTOR
Q3207	BC847B	TRANSISTOR
Q3208	BC847B	TRANSISTOR
Q3209	BC847B	TRANSISTOR
Q3401	BC847B	TRANSISTOR

Cct Ref	Parts Number	Description
Q3402	BC847B	TRANSISTOR
Q3601	BC847B	TRANSISTOR
TRANSFORMERS		
T501	ETH19Y173AY	TRANSFORMER
T801	ETS42AE226AD	TRANSFORMER
T802	ETP35KAN619U	TRANSFORMER
COILS		
J208	EXCELSA35V	COIL
L101	TLT100K991R	COIL
L102	TLT068K991R	COIL
L103	EXCELSA35B	COIL
L104	TLTACT4R7K	COIL
L105	TLTACTR47K	COIL
L106	TLTACT100K	COIL
L107	TLTACT6R8K	COIL
L114	ELJFC2R2KF	COIL
L115	ELJFC2R2KF	COIL
L301	TLTACT4R7K	COIL
L302	TLTACT4R7K	COIL
L451	EXCELSA35T	COIL
L501	EXCELSA35T	COIL
L580	ELC08D682E	COIL
L581	ELH5L6117	COIL
L582	ELC18B102E	COIL
L583	ELC18B101L	COIL
L601	TLTACT4R7K	COIL
L602	TLTACT4R7K	COIL
L603	TLTACT4R7K	COIL
L604	TLTACT4R7K	COIL
L606	TLTACT4R7K	COIL
L607	ELJFC2R2KF	COIL
L701	ELC10D682E	COIL
L850	EXCELSA35T	COIL
L851	EXCELSA35T	COIL
L852	ELEIE470KA	COIL
L855	EXCELSA35T	COIL
L856	EXCELSA39V	COIL
L901	EXCELSA24T	COIL
L902	EXCELSA24T	COIL
L1061	TLT331K991R	COIL
L1103	TLTACT100K	COIL
L1104	EXCELSA35T	COIL
L1105	ELJFC2R2KF	COIL
L1900	EXCELD2R25V	COIL
L2101	TLTACT100K	COIL
L2103	EXCELSA35T	COIL
L2104	TLTACT4R7K	COIL
L3001	ELEMV1R5MA	COIL
L3002	ELEMV1R5MA	COIL
L3003	ELEMV1R5MA	COIL
L3004	ELEMV1R5MA	COIL
L3005	ELEBR2R2KA	COIL
L3006	ELEBR2R2KA	COIL
L3007	TLTACT2R2K	COIL
L3201	ELEBR6R8KA	COIL
L3202	ELEBR6R8KA	COIL
L3203	TLT390K991R	COIL
L3204	TLT331K991R	COIL
L3401	ELESN2R2KA	COIL
L3402	ELESN2R2KA	COIL
FILTERS		
L802	ELF18N012A	LINE FILTER
L804	ELF18N012A	LINE FILTER
X101	EFCT6504BF	FILTER
X102	EFCT7004BF	CERAMIC FILTER

Cct Ref	Parts Number	Description
CRYSTALS		
X601	4730007267	CRYSTAL
X1101	TSSA121	CRYSTAL
X2101	4730007158	CRYSTAL
RESISTORS		
	ERC12GK825	SOLID 0.5W 10% 8M2 Ω
JA28	ERJ6GEY0R00	S.M.CARB 0.1W 5% 0 Ω
JA54	ERJ6GEY0R00	S.M.CARB 0.1W 5% 0 Ω
JA52	ERJ6GEY0R00	S.M.CARB 0.1W 5% 0 Ω
JA49	ERJ6GEY0R00	S.M.CARB 0.1W 5% 0 Ω
JA48	ERJ6GEY0R00	S.M.CARB 0.1W 5% 0 Ω
JA47	ERJ6GEY0R00	S.M.CARB 0.1W 5% 0 Ω
JA45	ERJ6GEY0R00	S.M.CARB 0.1W 5% 0 Ω
JA44	ERJ6GEY0R00	S.M.CARB 0.1W 5% 0 Ω
JA40	ERJ6GEY0R00	S.M.CARB 0.1W 5% 0 Ω
JSE35	ERJ6GEY0R00	S.M.CARB 0.1W 5% 0 Ω
JA39	ERJ6GEY0R00	S.M.CARB 0.1W 5% 0 Ω
JA38	ERJ6GEY0R00	S.M.CARB 0.1W 5% 0 Ω
JA37	ERJ6GEY0R00	S.M.CARB 0.1W 5% 0 Ω
JA36	ERJ6GEY0R00	S.M.CARB 0.1W 5% 0 Ω
JA3	ERJ6GEY0R00	S.M.CARB 0.1W 5% 0 Ω
JA55	ERJ6GEY0R00	S.M.CARB 0.1W 5% 0 Ω
JA27	ERJ6GEY0R00	S.M.CARB 0.1W 5% 0 Ω
JSE26	ERJ6GEY0R00	S.M.CARB 0.1W 5% 0 Ω
JA57	ERJ6GEY0R00	S.M.CARB 0.1W 5% 0 Ω
JA26	ERJ6GEY0R00	S.M.CARB 0.1W 5% 0 Ω
JSM7	ERJ6GEY0R00	S.M.CARB 0.1W 5% 0 Ω
JSM14	ERJ6GEY0R00	S.M.CARB 0.1W 5% 0 Ω
JSE48	ERJ6GEY0R00	S.M.CARB 0.1W 5% 0 Ω
JSE42	ERJ6GEY0R00	S.M.CARB 0.1W 5% 0 Ω
JSE3	ERJ6GEY0R00	S.M.CARB 0.1W 5% 0 Ω
JSE33	ERJ6GEY0R00	S.M.CARB 0.1W 5% 0 Ω
JA58	ERJ6GEY0R00	S.M.CARB 0.1W 5% 0 Ω
JSE18	ERJ6GEY0R00	S.M.CARB 0.1W 5% 0 Ω
JSE13	ERJ6GEY0R00	S.M.CARB 0.1W 5% 0 Ω
JSE12	ERJ6GEY0R00	S.M.CARB 0.1W 5% 0 Ω
JSE10	ERJ6GEY0R00	S.M.CARB 0.1W 5% 0 Ω
JA9	ERJ6GEY0R00	S.M.CARB 0.1W 5% 0 Ω
JA60	ERJ6GEY0R00	S.M.CARB 0.1W 5% 0 Ω
JSE4	ERJ6GEY0R00	S.M.CARB 0.1W 5% 0 Ω
JA10	ERJ6GEY0R00	S.M.CARB 0.1W 5% 0 Ω
JA1	ERJ6GEY0R00	S.M.CARB 0.1W 5% 0 Ω
JA22	ERJ6GEY0R00	S.M.CARB 0.1W 5% 0 Ω
JA13	ERJ6GEY0R00	S.M.CARB 0.1W 5% 0 Ω
JA12	ERJ6GEY0R00	S.M.CARB 0.1W 5% 0 Ω
JA11	ERJ6GEY0R00	S.M.CARB 0.1W 5% 0 Ω
JA15	ERJ6GEY0R00	S.M.CARB 0.1W 5% 0 Ω
JA14	ERJ6GEY0R00	S.M.CARB 0.1W 5% 0 Ω
JA16	ERJ6GEY0R00	S.M.CARB 0.1W 5% 0 Ω
JA25	ERJ6GEY0R00	S.M.CARB 0.1W 5% 0 Ω
JA2	ERJ6GEY0R00	S.M.CARB 0.1W 5% 0 Ω
JA17	ERJ6GEY0R00	S.M.CARB 0.1W 5% 0 Ω
JA1	ERJ8GEY0R00	S.M.CARB .125W 5% 0 Ω
JA5	ERJ8GEY0R00	S.M.CARB .125W 5% 0 Ω
JA51	ERJ8GEY0R00	S.M.CARB .125W 5% 0 Ω
JA53	ERJ8GEY0R00	S.M.CARB .125W 5% 0 Ω
JA56	ERJ8GEY0R00	S.M.CARB .125W 5% 0 Ω
JSE49	ERJ8GEY0R00	S.M.CARB .125W 5% 0 Ω
JA8	ERJ8GEY0R00	S.M.CARB .125W 5% 0 Ω
JA50	ERJ8GEY0R00	S.M.CARB .125W 5% 0 Ω
JA33	ERJ8GEY0R00	S.M.CARB .125W 5% 0 Ω
JA59	ERJ8GEY0R00	S.M.CARB .125W 5% 0 Ω
JA23	ERJ8GEY0R00	S.M.CARB .125W 5% 0 Ω
JA43	ERJ8GEY0R00	S.M.CARB .125W 5% 0 Ω
JA2	ERJ8GEY0R00	S.M.CARB .125W 5% 0 Ω
JA35	ERJ8GEY0R00	S.M.CARB .125W 5% 0 Ω

Cct Ref	Parts Number	Description			
JA34	ERJ8GEY0R00	S.M.CARB	.125W	5%	0 Ω
JA61	ERJ8GEY0R00	S.M.CARB	.125W	5%	0 Ω
JA29	ERJ8GEY0R00	S.M.CARB	.125W	5%	0 Ω
JA46	ERJ8GEY0R00	S.M.CARB	.125W	5%	0 Ω
JA32	ERJ8GEY0R00	S.M.CARB	.125W	5%	0 Ω
JA31	ERJ8GEY0R00	S.M.CARB	.125W	5%	0 Ω
JA30	ERJ8GEY0R00	S.M.CARB	.125W	5%	0 Ω
JA21	ERJ8GEY0R00	S.M.CARB	.125W	5%	0 Ω
R101	ERJ6GEYJ331	S.M.CARB	0.1W	5%	330 Ω
R102	ERJ6GEYJ103	S.M.CARB	0.1W	5%	10K Ω
R103	ERJ6GEYJ102	S.M.CARB	0.1W	5%	1K Ω
R104	ERJ6GEYJ331	S.M.CARB	0.1W	5%	330 Ω
R105	ERJ6GEYJ101	S.M.CARB	0.1W	5%	100 Ω
R106	ERJ6GEYJ680	S.M.CARB	0.1W	5%	68 Ω
R107	ERJ6GEYJ102	S.M.CARB	0.1W	5%	1K Ω
R108	ERJ6GEYJ103	S.M.CARB	0.1W	5%	10K Ω
R109	ERJ6GEYJ103	S.M.CARB	0.1W	5%	10K Ω
R110	ERJ6GEYJ471	S.M.CARB	0.1W	5%	470 Ω
R111	ERJ6GEYJ393	S.M.CARB	0.1W	5%	39K Ω
R112	ERJ6GEYJ101	S.M.CARB	0.1W	5%	100 Ω
R113	ERJ6GEYJ223	S.M.CARB	0.1W	5%	22K Ω
R116	ERJ6GEYJ562	S.M.CARB	0.1W	5%	5K6 Ω
R117	ERJ6GEYJ222	S.M.CARB	0.1W	5%	2K2 Ω
R118	ERJ6GEYJ102	S.M.CARB	0.1W	5%	1K Ω
R121	ERJ6GEYJ471	S.M.CARB	0.1W	5%	470 Ω
R251	ERJ6GEYJ101	S.M.CARB	0.1W	5%	100 Ω
R252	ERJ6GEYJ392	S.M.CARB	0.1W	5%	3K9 Ω
R253	ERJ6GEYJ103	S.M.CARB	0.1W	5%	10K Ω
R254	ERJ6GEYJ101	S.M.CARB	0.1W	5%	100 Ω
R255	ERJ6GEYJ103	S.M.CARB	0.1W	5%	10K Ω
R256	ERJ6GEYJ471	S.M.CARB	0.1W	5%	470 Ω
R257	ERJ6GEYJ680	S.M.CARB	0.1W	5%	68 Ω
R258	ERJ6GEYJ392	S.M.CARB	0.1W	5%	3K9 Ω
R259	ERJ6GEYJ680	S.M.CARB	0.1W	5%	68 Ω
R260	ERJ6GEYJ103	S.M.CARB	0.1W	5%	10K Ω
R261	ERJ6GEYJ471	S.M.CARB	0.1W	5%	470 Ω
R262	ERJ6GEYJ103	S.M.CARB	0.1W	5%	10K Ω
R263	ERJ6GEYJ473	S.M.CARB	0.1W	5%	47K Ω
R264	ERJ6GEYJ103	S.M.CARB	0.1W	5%	10K Ω
R265	ERD25TJ2R2	CARBON	0.25W	5%	2R2 Ω
R266	ERD25TJ2R2	CARBON	0.25W	5%	2R2 Ω
R267	ERF7ZK4R7	WOUND	7W	10%	4R7 Ω
R268	ERJ6GEYJ103	S.M.CARB	0.1W	5%	10K Ω
R269	ERQ14AJ101	METAL	0.25W	5%	100 Ω
R271	ERJ6GEYJ103	S.M.CARB	0.1W	5%	10K Ω
R272	ERF7ZK4R7	WOUND	7W	10%	4R7 Ω
R301	ERJ6GEYJ391	S.M.CARB	0.1W	5%	390 Ω
R302	ERJ6GEYJ102	S.M.CARB	0.1W	5%	1K Ω
R303	ERJ6GEYJ750	S.M.CARB	0.1W	5%	75 Ω
R304	ERJ6GEYJ331	S.M.CARB	0.1W	5%	330 Ω
R305	ERJ6GEYJ391	S.M.CARB	0.1W	5%	390 Ω
R306	ERJ6GEYJ102	S.M.CARB	0.1W	5%	1K Ω
R307	ERJ6GEYJ750	S.M.CARB	0.1W	5%	75 Ω
R308	ERJ6GEYJ331	S.M.CARB	0.1W	5%	330 Ω
R309	ERJ6GEYJ391	S.M.CARB	0.1W	5%	390 Ω
R310	ERJ6GEYJ102	S.M.CARB	0.1W	5%	1K Ω
R311	ERJ6GEYJ750	S.M.CARB	0.1W	5%	75 Ω
R312	ERJ6GEYJ331	S.M.CARB	0.1W	5%	330 Ω
R351	ERJ6GEYJ302	S.M.CARB	0.1W	5%	3K Ω
R352	ERJ6GEYJ302	S.M.CARB	0.1W	5%	3K Ω
R353	ERJ6GEYJ302	S.M.CARB	0.1W	5%	3K Ω
R354	ERJ6GEYJ102	S.M.CARB	0.1W	5%	1K Ω
R355	ERJ6GEYJ102	S.M.CARB	0.1W	5%	1K Ω
R356	ERJ6GEYJ102	S.M.CARB	0.1W	5%	1K Ω
R357	ERDS1TJ114	CARBON	0.5W	5%	110K Ω
R358	ERDS1TJ114	CARBON	0.5W	5%	110K Ω

Cct Ref	Parts Number	Description			
R359	ERDS1TJ114	CARBON	0.5W	5%	110K Ω
R363	ERD25TJ103	CARBON	0.25W	5%	10K Ω
R364	ERD25TJ103	CARBON	0.25W	5%	10K Ω
R365	ERD25TJ103	CARBON	0.25W	5%	10K Ω
R366	ERDS1TJ152	CARBON	0.5W	5%	1K5 Ω
R367	ERDS1TJ152	CARBON	0.5W	5%	1K5 Ω
R368	ERDS1TJ152	CARBON	0.5W	5%	1K5 Ω
R369	ERD25TJ472	CARBON	0.25W	5%	4K7 Ω
R370	ERJ6GEYJ102	S.M.CARB	0.1W	5%	1K Ω
R372	ERQ12AJ121	FUSIBLE	0.5W	5%	120 Ω
R373	ERJ6GEYJ220	S.M.CARB	0.1W	5%	22 Ω
R374	ERD25TJ274	CARBON	0.25W	5%	270K Ω
R375	ERJ6GEYJ684	S.M.CARB	0.1W	5%	680K Ω
R376	ERJ6GEYJ183	S.M.CARB	0.1W	5%	18K Ω
R377	ERQ12HKR22	FUSIBLE	0.5W	5%	R22 Ω
R381	ERJ6GEYJ473	S.M.CARB	0.1W	5%	47K Ω
R451	ERJ6GEYJ223	S.M.CARB	0.1W	5%	22K Ω
R452	ERJ6GEY0R00	S.M.CARB	0.1W	5%	0 Ω
R453	ERJ6GEY0R00	S.M.CARB	0.1W	5%	0 Ω
R454	ERJ6GEYJ752	S.M.CARB	0.1W	5%	7K5 Ω
R455	ERJ6GEYJ222	S.M.CARB	0.1W	5%	2K2 Ω
R456	ERJ6GEYJ104	S.M.CARB	0.1W	5%	100K Ω
R457	ERJ6GEYJ223	S.M.CARB	0.1W	5%	22K Ω
R458	ERD25TJ1R5	CARBON	0.25W	5%	1R5 Ω
R459	ERJ6GEYJ101	S.M.CARB	0.1W	5%	100 Ω
R460	ERDS1TJ331	CARBON	0.5W	5%	330 Ω
R461	ERW2PK1R2	WOUND	2W	10%	1R2 Ω
R463	ERD25TJ222	CARBON	0.25W	5%	2K2 Ω
R464	ERJ6GEYJ182	S.M.CARB	0.1W	5%	1K8 Ω
R465	ERJ6GEYJ681	S.M.CARB	0.1W	5%	680 Ω
R502	ERJ6GEYJ511	S.M.CARB	0.1W	5%	510 Ω
R506	ERD25TJ560	CARBON	0.25W	5%	56 Ω
R507	ERG2FJ470H	METAL	2W	5%	47 Ω
R509	ERDS1TJ152	CARBON	0.5W	5%	1K5 Ω
R510	ERDS1FJ152	CARBON	0.5W	5%	1K5 Ω
R555	ERQ12HKR33	METAL	0.5W	5%	R33 Ω
R558	ERDS1TJ124	CARBON	0.5W	5%	120K Ω
R559	ERQ12HKR33	METAL	0.5W	5%	R33 Ω
R560	ERJ6GEYJ274	S.M.CARB	0.1W	5%	270K Ω
R561	ERJ6GEYJ273	S.M.CARB	0.1W	5%	27K Ω
R563	ERJ6GEYJ684	S.M.CARB	0.1W	5%	680K Ω
R564	ERJ6GEYJ623	S.M.CARB	0.1W	5%	62K Ω
R566	ERJ6GEYJ563	S.M.CARB	0.1W	5%	56K Ω
R567	ERF7ZK1R0	WOUND	7W	10%	1 Ω
R580	ERG1SJ101	METAL	1W	5%	100 Ω
R581	ERG1SJ152	METAL	1W	5%	1K5 Ω
R582	ERG3FJ102H	METAL	3W	5%	1K Ω
R601	ERJ6GEYJ101	S.M.CARB	0.1W	5%	100 Ω
R602	ERJ6GEYJ821	S.M.CARB	0.1W	5%	820 Ω
R603	ERJ8GEYJ103	S.M.CARB	.125W	5%	10K Ω
R604	ERJ6GEYJ101	S.M.CARB	0.1W	5%	100 Ω
R605	ERD25TJ331	CARBON	0.25W	5%	330 Ω
R606	ERD25TJ331	CARBON	0.25W	5%	330 Ω
R607	ERJ6GEYJ821	S.M.CARB	0.1W	5%	820 Ω
R608	ERJ6GEYJ271	S.M.CARB	0.1W	5%	270 Ω
R609	ERJ6GEYJ122	S.M.CARB	0.1W	5%	1K2 Ω
R610	ERJ6GEY0R00	S.M.CARB	0.1W	5%	0 Ω
R611	ERJ6GEYJ103	S.M.CARB	0.1W	5%	10K Ω
R612	ERJ6GEYJ101	S.M.CARB	0.1W	5%	100 Ω
R613	ERJ6GEYJ152	S.M.CARB	0.1W	5%	1K5 Ω
R622	ERJ6GEY0R00	S.M.CARB	0.1W	5%	0 Ω
R636	ERJ6GEYJ750	S.M.CARB	0.1W	5%	75 Ω
R645	ERJ6GEYJ103	S.M.CARB	0.1W	5%	10K Ω
R647	ERJ6GEYJ472	S.M.CARB	0.1W	5%	4K7 Ω
R648	ERJ6GEYJ152	S.M.CARB	0.1W	5%	1K5 Ω
R650	ERJ6GEYJ750	S.M.CARB	0.1W	5%	75 Ω

Cct Ref	Parts Number	Description				
R651	ERJ6GEYJ750	S.M.CARB	0.1W	5%	75 Ω	
R652	ERJ6GEYJ102	S.M.CARB	0.1W	5%	1K Ω	
R654	ERJ6GEYJ622	S.M.CARB	0.1W	5%	6K2 Ω	
R655	ERJ6GEYJ103	S.M.CARB	0.1W	5%	10K Ω	
R658	ERJ6GEYJ153	S.M.CARB	0.1W	5%	15K Ω	
R659	ERJ6GEY0R00	S.M.CARB	0.1W	5%	0 Ω	
R660	ERJ6GEY0R00	S.M.CARB	0.1W	5%	0 Ω	
R701	ERQ12AJ101	FUSIBLE	0.5W	5%	100 Ω	△
R702	ERQ12HJ330	FUSIBLE	0.5W	5%	33 Ω	△
R703	ERG2FJ821	METAL	2W	5%	820 Ω	△
R704	ERJ6GEYJ563	S.M.CARB	0.1W	5%	56K Ω	
R705	ERJ6GEYJ104	S.M.CARB	0.1W	5%	100K Ω	
R706	ERJ6GEYJ103	S.M.CARB	0.1W	5%	10K Ω	
R707	ERJ6GEYJ391	S.M.CARB	0.1W	5%	390 Ω	
R708	ERJ6GEYJ393	S.M.CARB	0.1W	5%	39K Ω	
R709	ERJ6GEYJ393	S.M.CARB	0.1W	5%	39K Ω	
R710	ERJ6GEYJ273	S.M.CARB	0.1W	5%	27K Ω	
R711	ERG1SJ101	METAL	1W	5%	100 Ω	
R712	ERJ6GEYJ102	S.M.CARB	0.1W	5%	1K Ω	
R801	ERC12ZGK335D	SOLID	0.5W	10%	3M3 Ω	
R803	ERC12ZGK335D	SOLID	0.5W	10%	3M3 Ω	
R805	ERD25TJ473	CARBON	0.25W	5%	47K Ω	
R806	ERD25TJ100	CARBON	0.25W	5%	10 Ω	
R807	ERD25TJ332	CARBON	0.25W	5%	3K3 Ω	
R809	ERD25TJ681	CARBON	0.25W	5%	680 Ω	
R810	ERW2PKR27	WOUND	2W	10%	R27 Ω	△
R811	ERW2PKR27	WOUND	2W	10%	R27 Ω	△
R812	ERD75TAJ825	CARBON	0.75W	5%	8M2 Ω	△
R813	ERF7ZK2R7	WOUND	7W	20%	2R7 Ω	△
R814	ERD25TJ473	CARBON	0.25W	5%	47K Ω	
R815	ERD25TJ222	CARBON	0.25W	5%	2K2 Ω	
R850	ERD25TJ122	CARBON	0.25W	5%	1K2 Ω	
R852	ERJ6GEY0R00	S.M.CARB	0.1W	5%	0 Ω	
R853	ERJ6GEYJ102	S.M.CARB	0.1W	5%	1K Ω	
R854	ERG2FJ223	METAL	2W	5%	22K Ω	△
R855	ERJ6GEYJ752	S.M.CARB	0.1W	5%	7K5 Ω	
R856	ERJ6GEYJ752	S.M.CARB	0.1W	5%	7K5 Ω	
R857	ERJ6GEYJ752	S.M.CARB	0.1W	5%	7K5 Ω	
R858	ERJ6GEYJ752	S.M.CARB	0.1W	5%	7K5 Ω	
R859	ERJ6GEYJ753	S.M.CARB	0.1W	5%	75K Ω	
R860	ERQ1CJP2R2	FUSIBLE	1W	10%	2R2 Ω	△
R861	ERD25TJ221	CARBON	0.25W	5%	220 Ω	
R862	ERD25TJ272	CARBON	0.25W	5%	2K7 Ω	
R863	ERDS1TJ560	CARBON	0.5W	5%	56 Ω	
R864	ERDS1TJ680	CARBON	0.5W	5%	68 Ω	
R865	ERJ6GEY0R00	S.M.CARB	0.1W	5%	0 Ω	
R867	ERJ6GEYJ103	S.M.CARB	0.1W	5%	10K Ω	
R868	ERJ6GEYJ223	S.M.CARB	0.1W	5%	22K Ω	
R869	ERJ6GEY0R00	S.M.CARB	0.1W	5%	0 Ω	
R870	ERJ6GEYJ272	S.M.CARB	0.1W	5%	2K7 Ω	
R871	ERJ6GEYJ153	S.M.CARB	0.1W	5%	15K Ω	
R872	ERG1SJ183	METAL	1W	5%	18K Ω	
R873	ERG1SJ223	METAL	1W	5%	22K Ω	
R874	ERD25TJ104	CARBON	0.25W	5%	100K Ω	
R876	ERJ6GEYJ103	S.M.CARB	0.1W	5%	10K Ω	
R877	ERW2PKR47	WOUND	2W	10%	R47 Ω	△
R878	ERJ6GEYJ473	S.M.CARB	0.1W	5%	47K Ω	
R882	ERG2FJ330H	METAL	2W	5%	33 Ω	△
R913	ERJ6GEYJ473	S.M.CARB	0.1W	5%	47K Ω	
R914	ERJ6GEYJ822	S.M.CARB	0.1W	5%	8K2 Ω	
R915	ERJ6GEYJ152	S.M.CARB	0.1W	5%	1K5 Ω	
R916	ERJ6GEYJ391	S.M.CARB	0.1W	5%	390 Ω	
R919	ERQ14AJW390	FUSIBLE	0.25W	5%	39 Ω	△
R920	ERQ14AJW390	FUSIBLE	0.25W	5%	39 Ω	△
R921	ERD25TJ471	CARBON	0.25W	5%	470 Ω	
R922	ERD25TJ393	CARBON	0.25W	5%	39K Ω	

Cct Ref	Parts Number	Description				
R923	ERD25TJ393	CARBON	0.25W	5%	39K Ω	
R924	ERDS1FJ390	CARBON	0.5W	5%	39 Ω	△
R925	ERJ6GEY0R00	S.M.CARB	0.1W	5%	0 Ω	
R926	ERJ6GEY0R00	S.M.CARB	0.1W	5%	0 Ω	
R927	ERD25TJ471	CARBON	0.25W	5%	470 Ω	
R928	ERD25TJ5R6	CARBON	0.25W	5%	5R6 Ω	
R929	ERDS1FJ471	CARBON	0.5W	5%	470 Ω	△
R930	ERD25TJ5R6	CARBON	0.25W	5%	5R6 Ω	
R931	ERDS1FJ390	CARBON	0.5W	5%	39 Ω	△
R935	ERQ14AJW3R9	FUSIBLE	0.25W	5%	3R9 Ω	△
R936	ERQ1CJP331	FUSIBLE	1W	5%	330 Ω	△
R951	ERJ6GEYJ391	S.M.CARB	0.1W	5%	390 Ω	
R952	ERJ6GEYJ102	S.M.CARB	0.1W	5%	1K Ω	
R953	ERJ6GEYJ750	S.M.CARB	0.1W	5%	75 Ω	
R954	ERJ6GEYJ391	S.M.CARB	0.1W	5%	390 Ω	
R1051	ERJ6GEYJ102	S.M.CARB	0.1W	5%	1K Ω	
R1062	ERJ6GEYJ271	S.M.CARB	0.1W	5%	270 Ω	
R1063	ERJ6GEYJ103	S.M.CARB	0.1W	5%	10K Ω	
R1101	ERJ6GEYJ101	S.M.CARB	0.1W	5%	100 Ω	
R1102	ERJ6GEYJ102	S.M.CARB	0.1W	5%	1K Ω	
R1103	ERJ6GEYJ331	S.M.CARB	0.1W	5%	330 Ω	
R1104	ERJ6GEYJ331	S.M.CARB	0.1W	5%	330 Ω	
R1105	ERJ6GEYJ101	S.M.CARB	0.1W	5%	100 Ω	
R1106	ERJ6GEYJ104	S.M.CARB	0.1W	5%	100K Ω	
R1107	ERJ6GEYJ104	S.M.CARB	0.1W	5%	100K Ω	
R1108	ERJ6GEYJ102	S.M.CARB	0.1W	5%	1K Ω	
R1109	ERJ6GEYJ472	S.M.CARB	0.1W	5%	4K7 Ω	
R1110	ERJ6GEYJ472	S.M.CARB	0.1W	5%	4K7 Ω	
R1111	ERJ6GEYJ473	S.M.CARB	0.1W	5%	47K Ω	
R1112	ERJ6GEYJ473	S.M.CARB	0.1W	5%	47K Ω	
R1113	ERJ6GEYJ101	S.M.CARB	0.1W	5%	100 Ω	
R1114	ERJ6GEYJ101	S.M.CARB	0.1W	5%	100 Ω	
R1115	ERJ6GEYJ471	S.M.CARB	0.1W	5%	470 Ω	
R1116	ERJ6GEYJ101	S.M.CARB	0.1W	5%	100 Ω	
R1117	ERJ6GEYJ101	S.M.CARB	0.1W	5%	100 Ω	
R1118	ERJ6GEYJ472	S.M.CARB	0.1W	5%	4K7 Ω	
R1119	ERJ6GEYJ472	S.M.CARB	0.1W	5%	4K7 Ω	
R1120	ERJ6GEYJ101	S.M.CARB	0.1W	5%	100 Ω	
R1121	ERJ6GEYJ101	S.M.CARB	0.1W	5%	100 Ω	
R1123	ERJ6GEYJ101	S.M.CARB	0.1W	5%	100 Ω	
R1125	ERJ6GEYJ472	S.M.CARB	0.1W	5%	4K7 Ω	
R1126	ERJ6GEYJ101	S.M.CARB	0.1W	5%	100 Ω	
R1127	ERJ6GEYJ101	S.M.CARB	0.1W	5%	100 Ω	
R1128	ERJ6GEYJ682	S.M.CARB	0.1W	5%	6K8 Ω	
R1129	ERJ6GEYJ682	S.M.CARB	0.1W	5%	6K8 Ω	
R1130	ERJ6GEYJ103	S.M.CARB	0.1W	5%	10K Ω	
R1131	ERJ6GEYJ103	S.M.CARB	0.1W	5%	10K Ω	
R1132	ERJ6GEYJ101	S.M.CARB	0.1W	5%	100 Ω	
R1133	ERJ6GEYJ273	S.M.CARB	0.1W	5%	27K Ω	
R1136	ERJ6GEYJ823	S.M.CARB	0.1W	5%	82K Ω	
R1137	ERJ6GEY0R00	S.M.CARB	0.1W	5%	0 Ω	
R1138	ERJ6GEYJ474	S.M.CARB	0.1W	5%	470K Ω	
R1139	ERJ6GEYJ471	S.M.CARB	0.1W	5%	470 Ω	
R1140	ERJ6GEYJ471	S.M.CARB	0.1W	5%	470 Ω	
R1141	ERJ6GEYJ471	S.M.CARB	0.1W	5%	470 Ω	
R1142	ERJ6GEYJ472	S.M.CARB	0.1W	5%	4K7 Ω	
R1145	ERJ6GEYJ101	S.M.CARB	0.1W	5%	100 Ω	
R1146	ERJ6GEYJ101	S.M.CARB	0.1W	5%	100 Ω	
R1147	ERJ6GEYJ101	S.M.CARB	0.1W	5%	100 Ω	
R1148	ERJ6GEYJ101	S.M.CARB	0.1W	5%	100 Ω	
R1149	ERJ6GEYJ223	S.M.CARB	0.1W	5%	22K Ω	
R1151	ERJ6GEYJ101	S.M.CARB	0.1W	5%	100 Ω	
R1152	ERJ6GEYJ101	S.M.CARB	0.1W	5%	100 Ω	
R1154	ERJ6GEYJ101	S.M.CARB	0.1W	5%	100 Ω	
R1155	ERJ6GEYJ101	S.M.CARB	0.1W	5%	100 Ω	
R1156	ERJ6GEYJ101	S.M.CARB	0.1W	5%	100 Ω	

Cct Ref	Parts Number	Description			
R1157	ERJ6GEYJ103	S.M.CARB	0.1W	5%	10K Ω
R1158	ERJ6GEY0R00	S.M.CARB	0.1W	5%	0 Ω
R1159	ERJ6GEY0R00	S.M.CARB	0.1W	5%	0 Ω
R1160	ERJ6GEYJ223	S.M.CARB	0.1W	5%	22K Ω
R1161	ERJ6GEYJ103	S.M.CARB	0.1W	5%	10K Ω
R1163	ERJ6GEY0R00	S.M.CARB	0.1W	5%	0 Ω
R1164	ERJ6GEY0R00	S.M.CARB	0.1W	5%	0 Ω
R1165	ERJ6GEY0R00	S.M.CARB	0.1W	5%	0 Ω
R1166	ERJ6GEY0R00	S.M.CARB	0.1W	5%	0 Ω
R1167	ERJ6GEYJ100	S.M.CARB	0.1W	5%	10 Ω
R1168	ERJ6GEYJ473	S.M.CARB	0.1W	5%	47K Ω
R1169	ERJ6GEYJ472	S.M.CARB	0.1W	5%	4K7 Ω
R1170	ERJ6GEYJ273	S.M.CARB	0.1W	5%	27K Ω
R1171	ERJ6GEYJ224	S.M.CARB	0.1W	5%	220K Ω
R1172	ERJ6GEYJ223	S.M.CARB	0.1W	5%	22K Ω
R1173	ERJ6GEYJ104	S.M.CARB	0.1W	5%	100K Ω
R1174	ERJ6GEYJ221	S.M.CARB	0.1W	5%	220 Ω
R1175	ERJ6GEYJ225	S.M.CARB	0.1W	5%	2M2 Ω
R1177	ERJ6GEYJ101	S.M.CARB	0.1W	5%	100 Ω
R1178	ERJ6GEY0R00	S.M.CARB	0.1W	5%	0 Ω
R1251	ERJ6GEYJ222	S.M.CARB	0.1W	5%	2K2 Ω
R1252	ERJ6GEYJ222	S.M.CARB	0.1W	5%	2K2 Ω
R1253	ERJ6GEYJ332	S.M.CARB	0.1W	5%	3K3 Ω
R1254	ERJ6GEYJ512	S.M.CARB	0.1W	5%	5K1 Ω
R1255	ERJ6GEYJ912	S.M.CARB	0.1W	5%	9K1 Ω
R1900	ERQ12HJ150	FUSIBLE	0.1W	5%	15 Ω [△]
R1901	ERJ6GEYJ273	S.M.CARB	0.1W	5%	27K Ω
R1902	ERJ6GEYJ472	S.M.CARB	0.1W	5%	4K7 Ω
R1903	ERJ6GEYJ103	S.M.CARB	0.1W	5%	10K Ω
R1904	ERDS1TJ6R8	CARBON	0.5W	5%	6R8 Ω
R1905	ERJ6GEYJ104	S.M.CARB	0.1W	5%	100K Ω
R1906	ERJ6GEYJ513	S.M.CARB	0.1W	5%	51K Ω
R1907	ERJ6GEYJ753	S.M.CARB	0.1W	5%	75K Ω
R1908	ERJ6GEYJ753	S.M.CARB	0.1W	5%	75K Ω
R1909	ERDS1TJ6R8	CARBON	0.5W	5%	6R8 Ω
R2101	ERJ6GEYJ103	S.M.CARB	0.1W	5%	10K Ω
R2102	ERJ6GEYJ101	S.M.CARB	0.1W	5%	100 Ω
R2103	ERJ6GEYJ101	S.M.CARB	0.1W	5%	100 Ω
R2104	ERJ6GEYJ101	S.M.CARB	0.1W	5%	100 Ω
R2105	ERJ6GEYJ101	S.M.CARB	0.1W	5%	100 Ω
R2106	ERJ6GEYJ101	S.M.CARB	0.1W	5%	100 Ω
R2107	ERJ6GEYJ101	S.M.CARB	0.1W	5%	100 Ω
R2108	ERJ6GEYJ101	S.M.CARB	0.1W	5%	100 Ω
R2109	ERJ6GEYJ183	S.M.CARB	0.1W	5%	18K Ω
R2110	ERJ6GEY0R00	S.M.CARB	0.1W	5%	0 Ω
R2111	ERJ6GEYJ221	S.M.CARB	0.1W	5%	220 Ω
R2112	ERJ6GEYJ102	S.M.CARB	0.1W	5%	1K Ω
R2113	ERJ6GEYJ562	S.M.CARB	0.1W	5%	5K6 Ω
R2114	ERJ6GEYJ101	S.M.CARB	0.1W	5%	100 Ω
R2115	ERJ6GEYJ222	S.M.CARB	0.1W	5%	2K2 Ω
R2116	ERJ6GEYJ101	S.M.CARB	0.1W	5%	100 Ω
R2117	ERJ6GEYJ101	S.M.CARB	0.1W	5%	100 Ω
R2118	ERJ6GEYJ222	S.M.CARB	0.1W	5%	2K2 Ω
R2119	ERJ6GEYJ101	S.M.CARB	0.1W	5%	100 Ω
R2120	ERJ6GEYJ222	S.M.CARB	0.1W	5%	2K2 Ω
R2302	ERJ6GEYJ104	S.M.CARB	0.1W	5%	100K Ω
R2303	ERJ6GEYJ101	S.M.CARB	0.1W	5%	100 Ω
R2304	ERJ6GEYJ471	S.M.CARB	0.1W	5%	470 Ω
R2305	ERJ6GEYJ102	S.M.CARB	0.1W	5%	1K Ω
R2306	ERJ6GEYJ103	S.M.CARB	0.1W	5%	10K Ω
R2308	ERJ6GEYJ104	S.M.CARB	0.1W	5%	100K Ω
R2309	ERJ6GEYJ101	S.M.CARB	0.1W	5%	100 Ω
R2310	ERJ6GEYJ471	S.M.CARB	0.1W	5%	470 Ω
R2311	ERJ6GEYJ102	S.M.CARB	0.1W	5%	1K Ω
R2312	ERJ6GEYJ103	S.M.CARB	0.1W	5%	10K Ω
R3001	ERJ6GEYJ101	S.M.CARB	0.1W	5%	100 Ω

Cct Ref	Parts Number	Description			
R3002	ERJ6GEYJ471	S.M.CARB	0.1W	5%	470 Ω
R3003	ERJ6GEYJ101	S.M.CARB	0.1W	5%	100 Ω
R3004	ERJ6GEYJ153	S.M.CARB	0.1W	5%	15K Ω
R3005	ERJ6GEYJ101	S.M.CARB	0.1W	5%	100 Ω
R3006	ERJ6GEYJ471	S.M.CARB	0.1W	5%	470 Ω
R3007	ERJ6GEYJ101	S.M.CARB	0.1W	5%	100 Ω
R3008	ERJ6GEYJ153	S.M.CARB	0.1W	5%	15K Ω
R3009	ERJ6GEYJ750	S.M.CARB	0.1W	5%	75 Ω
R3010	ERJ6GEYJ750	S.M.CARB	0.1W	5%	75 Ω
R3011	ERJ6GEYJ750	S.M.CARB	0.1W	5%	75 Ω
R3012	ERJ6GEYJ750	S.M.CARB	0.1W	5%	75 Ω
R3013	ERJ6GEYJ101	S.M.CARB	0.1W	5%	100 Ω
R3014	ERJ6GEYJ471	S.M.CARB	0.1W	5%	470 Ω
R3015	ERJ6GEYJ101	S.M.CARB	0.1W	5%	100 Ω
R3016	ERJ6GEYJ153	S.M.CARB	0.1W	5%	15K Ω
R3017	ERJ6GEYJ101	S.M.CARB	0.1W	5%	100 Ω
R3018	ERJ6GEYJ471	S.M.CARB	0.1W	5%	470 Ω
R3019	ERJ6GEYJ101	S.M.CARB	0.1W	5%	100 Ω
R3020	ERJ6GEYJ153	S.M.CARB	0.1W	5%	15K Ω
R3021	ERJ6GEYJ750	S.M.CARB	0.1W	5%	75 Ω
R3022	ERJ6GEYJ102	S.M.CARB	0.1W	5%	1K Ω
R3023	ERJ6GEYJ123	S.M.CARB	0.1W	5%	12K Ω
R3024	ERJ6GEYJ472	S.M.CARB	0.1W	5%	4K7 Ω
R3025	ERJ6GEYJ750	S.M.CARB	0.1W	5%	75 Ω
R3026	ERJ6GEYJ750	S.M.CARB	0.1W	5%	75 Ω
R3044	ERJ6GEYJ750	S.M.CARB	0.1W	5%	75 Ω
R3046	ERJ6GEYJ101	S.M.CARB	0.1W	5%	100 Ω
R3047	ERJ6GEYJ101	S.M.CARB	0.1W	5%	100 Ω
R3048	ERJ6GEYJ103	S.M.CARB	0.1W	5%	10K Ω
R3049	ERJ6GEYJ101	S.M.CARB	0.1W	5%	100 Ω
R3050	ERJ6GEYJ103	S.M.CARB	0.1W	5%	10K Ω
R3057	ERJ6GEYJ750	S.M.CARB	0.1W	5%	75 Ω
R3202	ERDS1TJ151	CARBON	0.5W	5%	150 Ω
R3203	ERDS1TJ151	CARBON	0.5W	5%	150 Ω
R3204	ERG2FJ221	METAL	2W	5%	220 Ω [△]
R3205	ERG2FJ221	METAL	2W	5%	220 Ω [△]
R3207	ERJ6GEYJ101	S.M.CARB	0.1W	5%	100 Ω
R3208	ERJ6GEYJ153	S.M.CARB	0.1W	5%	15K Ω
R3209	ERJ6GEYJ101	S.M.CARB	0.1W	5%	100 Ω
R3210	ERJ6GEYJ153	S.M.CARB	0.1W	5%	15K Ω
R3211	ERJ6GEYJ223	S.M.CARB	0.1W	5%	22K Ω
R3212	ERJ6GEYJ223	S.M.CARB	0.1W	5%	22K Ω
R3213	ERJ6GEYJ102	S.M.CARB	0.1W	5%	1K Ω
R3214	ERJ6GEYJ683	S.M.CARB	0.1W	5%	68K Ω
R3215	ERJ6GEYJ302	S.M.CARB	0.1W	5%	3K Ω
R3216	ERJ6GEYJ750	S.M.CARB	0.1W	5%	75 Ω
R3217	ERJ6GEYJ223	S.M.CARB	0.1W	5%	22K Ω
R3218	ERJ6GEYJ223	S.M.CARB	0.1W	5%	22K Ω
R3219	ERJ6GEYJ102	S.M.CARB	0.1W	5%	1K Ω
R3220	ERJ6GEYJ683	S.M.CARB	0.1W	5%	68K Ω
R3221	ERJ6GEYJ302	S.M.CARB	0.1W	5%	3K Ω
R3222	ERJ6GEYJ223	S.M.CARB	0.1W	5%	22K Ω
R3223	ERJ6GEYJ223	S.M.CARB	0.1W	5%	22K Ω
R3224	ERJ6GEYJ102	S.M.CARB	0.1W	5%	1K Ω
R3225	ERJ6GEYJ683	S.M.CARB	0.1W	5%	68K Ω
R3226	ERJ6GEYJ302	S.M.CARB	0.1W	5%	3K Ω
R3227	ERJ6GEYJ102	S.M.CARB	0.1W	5%	1K Ω
R3228	ERJ6GEYJ273	S.M.CARB	0.1W	5%	27K Ω
R3229	ERJ6GEYJ103	S.M.CARB	0.1W	5%	10K Ω
R3230	ERJ6GEYJ302	S.M.CARB	0.1W	5%	3K Ω
R3231	ERJ6GEYJ122	S.M.CARB	0.1W	5%	1K2 Ω
R3232	ERJ6GEYJ242	S.M.CARB	0.1W	5%	2K4 Ω
R3233	ERJ6GEYJ391	S.M.CARB	0.1W	5%	390 Ω
R3234	ERJ6GEYJ102	S.M.CARB	0.1W	5%	1K Ω
R3402	ERJ6GEYJ750	S.M.CARB	0.1W	5%	75 Ω
R3403	ERJ6GEYJ101	S.M.CARB	0.1W	5%	100 Ω

Cct Ref	Parts Number	Description			
R3404	ERJ6GEYJ242	S.M.CARB	0.1W	5%	2K4 Ω
R3405	ERJ6GEYJ104	S.M.CARB	0.1W	5%	100K Ω
R3406	ERJ6GEYJ301	S.M.CARB	0.1W	5%	300 Ω
R3407	ERJ6GEYJ123	S.M.CARB	0.1W	5%	12K Ω
R3408	ERJ6GEYJ472	S.M.CARB	0.1W	5%	4K7 Ω
R3409	ERJ6GEYJ750	S.M.CARB	0.1W	5%	75 Ω
R3601	ERJ6GEYJ101	S.M.CARB	0.1W	5%	100 Ω
R3602	ERJ6GEYJ101	S.M.CARB	0.1W	5%	100 Ω
R3603	ERJ6GEYJ101	S.M.CARB	0.1W	5%	100 Ω
R3604	ERJ6GEYJ101	S.M.CARB	0.1W	5%	100 Ω
R3605	ERJ6GEYJ101	S.M.CARB	0.1W	5%	100 Ω
R3606	ERJ6GEYJ101	S.M.CARB	0.1W	5%	100 Ω
R3607	ERJ6GEYJ472	S.M.CARB	0.1W	5%	4K7 Ω
R3608	ERJ6GEYJ752	S.M.CARB	0.1W	5%	7K5 Ω
R3609	ERJ6GEY0R00	S.M.CARB	0.1W	5%	0 Ω
R3610	ERJ6GEYJ102	S.M.CARB	0.1W	5%	1K Ω
R3613	ERJ6GEYJ391	S.M.CARB	0.1W	5%	390 Ω
R3614	ERJ6GEYJ391	S.M.CARB	0.1W	5%	390 Ω

CAPACITORS

C101	ECJ2VB1C104K	ELECT	350V	100nF	
C102	ECJ2VB1C104K	ELECT	350V	100nF	
C103	ECJ2VF1H104Z	ELECT	350V	100nF	
C105	ECUV1H560JCX	S.M. CAP	50V	56pF	
C106	ECUV1H560JCX	S.M. CAP	50V	56pF	
C107	ECJ2VF1H104Z	ELECT	350V	100nF	
C108	ECA1CM470GB	ELECT	16V	47μF	
C109	ECUV1H102JCX	S.M. CAP	50V	1nF	
C110	ECUV1H103ZFX	S.M. CAP	50V	10nF	
C111	ECA1HMR33GB	ELECT	50V	10nF	
C114	ECJ2VF1H104Z	ELECT	350V	100nF	
C115	ECUV1H103ZFX	S.M. CAP	50V	10nF	
C116	ECA1CM221GB	ELECT	16V	220μF	
C117	ECUV1H103ZFX	S.M. CAP	50V	10nF	
C118	ECJ2VF1H104Z	ELECT	350V	100nF	
C119	ECA1CM221GB	ELECT	16V	220μF	
C120	ECA1CM221GB	ELECT	16V	220μF	
C121	ECUV1H103KBX	S.M. CAP	50V	10nF	
C124	ECUV1H220JCX	S.M. CAP	50V	22pF	
C125	ECUV1H100DCX	S.M. CAP	50V	10pF	
C133	ECUV1H104KBX	S.M. CAP	50V	100nF	
C134	ECUV1H104KBX	S.M. CAP	50V	100nF	
C135	ECUV1H104KBW	S.M. CAP	50V	100nF	
C136	ECUV1H104KBX	S.M. CAP	50V	100nF	
C138	ECUV1H104KBX	S.M. CAP	50V	100nF	
C251	ECA1EM470GB	ELECT	25V	47μF	
C252	ECUV1H223KBX	S.M. CAP	50V	22nF	
C253	ECA1HM4R7GB	ELECT	50V	4.7μF	
C254	ECQM1H224J	FILM	50V	220nF	
C255	ECA1EM101GB	ELECT	25V	100μF	
C256	ECUV1H223KBX	S.M. CAP	50V	22nF	
C257	ECA1HM4R7GB	ELECT	50V	4.7μF	
C258	ECA1EM470GB	ELECT	25V	47μF	
C259	ECQM1H224J	FILM	50V	220nF	
C260	ECA1VM102GB	ELECT	35V	1nF	
C261	ECA1VM102GB	ELECT	35V	1nF	
C262	ECQM1H104J	FILM	50V	100nF	
C263	ECA1HM010GB	ELECT	50V	1μF	
C264	ECA1HHG222E	ELECT	50V	1μF	
C265	ECQM1H104J	FILM	50V	100nF	
C266	ECA1HM010GB	ELECT	50V	1μF	
C267	ECJ2VB1H104K	ELECT	350V	100nF	
C268	ECJ2VB1H104K	ELECT	350V	100nF	
C270	ECJ2VB1H104K	ELECT	350V	100nF	
C301	ECJ2VB1C104K	ELECT	350V	100nF	
C302	ECJ2VB1C104K	ELECT	350V	100nF	
C303	ECJ2VB1C104K	ELECT	350V	100nF	

Cct Ref	Parts Number	Description			
C304	ECA1CM100GB	ELECT	16V	10μF	
C354	ECQM2104KZ	FILM	250V	100nF	
C355	ECUV1H471JCX	S.M. CAP	50V	470pF	
C356	ECUV1H471JCX	S.M. CAP	50V	470pF	
C357	ECUV1H471JCX	S.M. CAP	50V	470pF	
C358	ECQM1H224J	FILM	50V	220nF	
C360	ECKC3D152J	CERAMIC	2KV	1.5nF	⚠
C361	ECA1HMR47GB	ELECT	50V	1.5nF	
C363	ECA1VM471GB	ELECT	35V	470μF	
C364	ECUV1H103ZFX	S.M. CAP	50V	10nF	
C366	ECA1CM100GB	ELECT	16V	10μF	
C451	ECUV1H102JX	S.M. CAP	50V	1nF	
C453	ECUV1H152KBX	S.M. CAP	50V	1.5pF	
C454	ECUV1H223KBM	S.M. CAP	50V	22nF	
C455	ECA1HM100GB	ELECT	50V	10μF	
C456	ECA1HHG221B	ELECT	50V	220μF	
C458	ECQB1222JF3	FILM	100V	2.2nF	
C459	222236516154	FILM	160V	150nF	
C461	ECCR2H270J	CERAMIC	500V	27pF	
C508	ECQV1H105JZ	FILM	50V	1μF	
C509	ECA1VM470B	ELECT	35V	47μF	
C510	ECUV1H104KBX	S.M. CAP	50V	100nF	
C511	ECQM2683JZ	FILM	250V	68nF	
C551	222237544182	FILM	440V	1.8nF	
C552	ECWH15H102JN	FILM	1500V	1nF	
C556	ECQF6303JZ	FILM	630V	1nF	
C557	ECKC2H471J	CERAMIC	500V	470pF	⚠
C558	ECA1HHG471E	ELECT	50V	470μF	
C561	ECA1EHG102B	ELECT	25V	470μF	
C562	ECKC2H101J	CERAMIC	500V	100pF	⚠
C563	ECA2EHG220B	ELECT	250V	20μF	
C564	ECEA2AU2R2	ELECT	100V	2.2μF	
C565	ECQP1H273J	FILM	100V	2.2μF	
C566	ECKC2H471J	CERAMIC	500V	470pF	⚠
C567	ECA1EHG102B	ELECT	25V	470pF	
C568	ECKC2H471J	CERAMIC	500V	470pF	⚠
C569	ECKC2H102J	CERAMIC	500V	1nF	⚠
C580	ECA2VM010B	ELECT	63V	1μF	
C581	ECWF2H125J	FILM	500V	1.2μF	⚠
C582	ECWF2H684J	FILM	500V	680nF	⚠
C583	ECWH15H822JN	FILM	1500V	8.2nF	
C584	TAC4R6T682JC	CERAMIC	400V	6.8μF	
C601	ECUV1H104KBX	S.M. CAP	50V	100nF	
C602	ECA1HM101GB	ELECT	50V	100μF	
C603	ECUV1H102JCX	S.M. CAP	50V	1nF	
C604	ECJ2VF1H223Z	ELECT	350V	22nF	
C605	ECA1HM101GB	ELECT	50V	100μF	
C606	ECA1HM3R3GB	ELECT	50V	3.3μF	
C607	ECJ2VF1H104Z	ELECT	350V	100nF	
C608	ECUV1H153KBX	S.M. CAP	50V	15nF	
C609	ECUV1H153KBX	S.M. CAP	50V	15nF	
C610	ECUV1H153KBX	S.M. CAP	50V	15nF	
C611	ECUV1H153KBX	S.M. CAP	50V	15nF	
C612	ECUV1H153KBX	S.M. CAP	50V	15nF	
C613	ECUV1H153KBX	S.M. CAP	50V	15nF	
C614	ECUV1H050CCX	S.M. CAP	50V	50pF	
C615	ECUV1H050CCX	S.M. CAP	50V	50pF	
C616	ECA1HM101GB	ELECT	50V	100μF	
C617	ECUV1H223KBX	S.M. CAP	50V	22nF	
C618	ECA1CM221GB	ELECT	16V	220μF	
C619	ECJ2VB1H473K	ELECT	350V	47nF	
C620	ECA1HM101GB	ELECT	50V	100μF	
C621	ECJ2VB1C104K	ELECT	350V	100nF	
C622	ECUV1H683KBX	S.M. CAP	50V	68nF	
C623	ECUV1H102JCX	S.M. CAP	50V	1nF	
C624	ECJ3VB1C474K	ELECT	3.5KV	470nF	

Cct Ref	Parts Number	Description			
C625	ECJ3VB1C474K	ELECT	3.5KV	470nF	
C626	ECJ3VB1C474K	ELECT	3.5KV	470nF	
C627	ECJ3VB1C474K	ELECT	3.5KV	470nF	
C628	ECA1CM100GB	ELECT	16V	10µF	
C629	ECUV1H104KBX	S.M. CAP	50V	100nF	
C630	ECUV1H100DCX	S.M. CAP	50V	10pF	
C631	ECUV1H683ZFX	S.M. CAP	50V	68nF	
C632	ECUV1H270JCX	S.M. CAP	50V	27pF	
C633	ECUV1H271JCX	S.M. CAP	50V	270pF	
C634	ECUV1H271JCX	S.M. CAP	50V	270pF	
C635	ECUV1H180JCX	S.M. CAP	50V	18pF	
C636	ECUV1H271JCX	S.M. CAP	50V	270pF	
C637	ECUV1H101JCX	S.M. CAP	50V	100pF	
C638	ECUV1H471JCX	S.M. CAP	50V	470pF	
C639	ECUV1H332KBM	S.M. CAP	50V	3.3nF	
C701	ECA1HHG101B	ELECT	50V	100µF	
C702	ECUV1H103KBX	S.M. CAP	50V	10nF	
C703	ECEA1HGE100	ELECT	50V	10µF	
C704	ECQB1H223K	FILM	50V	22nF	
C705	ECQB1H152K	FILM	50V	1.5nF	
C801	222233510224	FILM	50V	220nF	
C804	ECQE2A474MWB	FILM	100V	470nF	
C806	ECKWNA101MBC	CERAMIC	400V	100µF	
C807	ECKC2H472J	CERAMIC	500V	4.7nF	△
C808	ECKC2H472J	CERAMIC	500V	4.7nF	△
C809	ECKC2H472J	CERAMIC	500V	4.7nF	△
C810	ECKC2H472J	CERAMIC	500V	4.7nF	△
C811	ECOS2GA221CA	ELECT	400V	220µF	
C814	ECKC3D102J	CERAMIC	2KV	1nF	△
C815	ECKC1H471J	CERAMIC	50V	470pF	
C816	EEUFC1E820B	CERAMIC	25V	82pF	
C817	ECQE6104K	FILM	600V	100nF	△
C818	ECKWNA332MEC	CERAMIC	250V	3.3nF	
C819	ECQB1H182K	FILM	50V	1.8nF	
C850	ECKC3D471JB	CERAMIC	2KV	470pF	△
C851	ECA2CM221E	ELECT	160V	220µF	
C852	ECA2CHG101E	ELECT	160V	100µF	
C853	ECKC2H471J	CERAMIC	500V	470pF	△
C854	ECA1EM102GB	ELECT	25V	100µF	
C855	ECKC2H471J	CERAMIC	500V	470pF	△
C856	ECA1AHG222B	ELECT	10V	470pF	
C857	ECKC2H471J	CERAMIC	500V	470pF	△
C858	ECEA1HGE102	ELECT	50V	470pF	
C859	ECJ2VF1H104Z	ELECT	350V	100nF	
C860	ECA1HM101GB	ELECT	50V	100µF	
C862	ECJ2VF1H104Z	ELECT	350V	100nF	
C863	ECA1HM101GB	ELECT	50V	100µF	
C864	ECJ2VF1H104Z	ELECT	350V	100nF	
C865	ECA1CM100GB	ELECT	16V	10µF	
C866	ECJ2VF1H104Z	ELECT	350V	100nF	
C867	ECA1CM100GB	ELECT	16V	10µF	
C868	ECA1CM100GB	ELECT	16V	10µF	
C869	ECA1EM101GB	ELECT	25V	100µF	
C870	ECA1EM471GB	ELECT	25V	470µF	
C871	ECA1CM102B	ELECT	16V	470µF	
C872	ECA1CM471GB	ELECT	16V	470µF	
C873	ECA1CM100GB	ELECT	16V	10µF	
C875	ECA2CM4R7B	ELECT	160V	10µF	
C876	ECA1AHG471E	ELECT	10V	470pF	
C902	ECA1VM101GB	ELECT	35V	100µF	
C903	ECUV1H472KBX	S.M. CAP	50V	4.7nF	
C904	ECUV1H472KBX	S.M. CAP	50V	4.7nF	
C906	ECUV1H471KBX	S.M. CAP	50V	470pF	
C908	ECUV1H151JCX	S.M. CAP	50V	150pF	
C909	ECKC2H472J	CERAMIC	500V	4.7nF	△
C910	ECKC2H472J	CERAMIC	500V	4.7nF	△

Cct Ref	Parts Number	Description			
C911	ECUV1H151JCX	S.M. CAP	50V	150pF	
C912	ECEA2CU100	ELECT	160V	10µF	
C913	ECA1HM101GB	ELECT	50V	100µF	
C914	ECA1HM101GB	ELECT	50V	100µF	
C916	ECEA2CGE100	ELECT	160V	10µF	
C950	ECJ2VB1C104K	ELECT	350V	100nF	
C1061	ECUV1H103KBX	S.M. CAP	50V	10nF	
C1062	ECA1HM101GB	ELECT	50V	100µF	
C1063	ECUV1H331JCX	S.M. CAP	50V	330pF	
C1101	ECJ2VF1H104Z	ELECT	350V	100nF	
C1102	ECA0JM101G	ELECT	6.3V	100µF	
C1103	ECUV1H220JCX	S.M. CAP	50V	22pF	
C1104	ECUV1H220JCX	S.M. CAP	50V	22pF	
C1105	ECUV1H101JCX	S.M. CAP	50V	100pF	
C1106	ECKC2H681J	CERAMIC	500V	680pF	△
C1108	ECJ2VB1H333K	ELECT	350V	33nF	
C1111	ECA1CM100GB	ELECT	16V	10µF	
C1112	ECUV1H103KBX	S.M. CAP	50V	10nF	
C1115	ECJ3VB1C474K	ELECT	3.5KV	470nF	
C1116	ECUV1H472KBX	S.M. CAP	50V	4.7nF	
C1117	ECJ2VF1H104Z	ELECT	350V	100nF	
C1118	ECUV1H103KBX	S.M. CAP	50V	10nF	
C1119	ECUV1H221JCX	S.M. CAP	50V	220pF	
C1120	ECJ2VF1H104Z	ELECT	350V	100nF	
C1121	ECUV1H221JCX	S.M. CAP	50V	220pF	
C1123	ECUV1H101JCX	S.M. CAP	50V	100pF	
C1124	ECUV1H101JCX	S.M. CAP	50V	100pF	
C1125	ECUV1H101JCX	S.M. CAP	50V	100pF	
C1126	ECUV1H101JCX	S.M. CAP	50V	100pF	
C1127	ECUV1H221JCX	S.M. CAP	50V	220pF	
C1128	ECUV1H223KBX	S.M. CAP	50V	22nF	
C1129	ECUV1H270JCX	S.M. CAP	50V	27pF	
C1900	ECQB1H153K	FILM	50V	15nF	
C1901	ECUV1H103KBX	S.M. CAP	50V	10nF	
C1903	ECA1EM470GB	ELECT	25V	47µF	
C1904	ECQB1H104J	FILM	50V	100nF	
C1905	ECQB1H104J	FILM	50V	100nF	
C1909	ECUV1H103KBX	S.M. CAP	50V	10nF	
C2101	ECUV1H102JCX	S.M. CAP	50V	1nF	
C2102	ECUV1H102JCX	S.M. CAP	50V	1nF	
C2103	ECUV1H102JCX	S.M. CAP	50V	1nF	
C2104	ECUV1H102JCX	S.M. CAP	50V	1nF	
C2105	ECUV1H102JCX	S.M. CAP	50V	1nF	
C2106	ECUV1H102JCX	S.M. CAP	50V	1nF	
C2107	ECUV1H102JCX	S.M. CAP	50V	1nF	
C2108	ECUV1H102JCX	S.M. CAP	50V	1nF	
C2109	ECUV1H102JCX	S.M. CAP	50V	1nF	
C2110	ECUV1H102JCX	S.M. CAP	50V	1nF	
C2111	ECA1CM100GB	ELECT	16V	10µF	
C2112	ECA1CM100GB	ELECT	16V	10µF	
C2113	ECA1HM3R3GB	ELECT	50V	3.3µF	
C2114	ECJ2VF1H104Z	ELECT	350V	100nF	
C2115	ECUV1H221JCX	S.M. CAP	50V	220pF	
C2116	ECUV1H221JCX	S.M. CAP	50V	220pF	
C2117	ECUV1H221JCX	S.M. CAP	50V	220pF	
C2118	ECUV1H221JCX	S.M. CAP	50V	220pF	
C2119	ECUV1H221JCX	S.M. CAP	50V	220pF	
C2120	ECUV1H221JCX	S.M. CAP	50V	220pF	
C2121	ECA1CM100GB	ELECT	16V	10µF	
C2122	ECJ2VF1H104Z	ELECT	350V	100nF	
C2123	ECUV1H221JCX	S.M. CAP	50V	220pF	
C2124	ECUV1H070DTX	S.M. CAP	50V	70pF	
C2125	ECUV1H470JCX	S.M. CAP	50V	47pF	
C2126	ECUV1H560JCX	S.M. CAP	50V	56pF	
C2127	ECUV1H010CCX	S.M. CAP	50V	1pF	
C2128	ECUV1H010CCX	S.M. CAP	50V	1pF	

Cct Ref	Parts Number	Description		
C2129	ECA1CM102B	ELECT	16V	1pF
C2130	ECA1CM331B	ELECT	16V	330µF
C2131	ECUV1H103ZFX	S.M. CAP	50V	10nF
C2132	ECUV1H103ZFX	S.M. CAP	50V	10nF
C2134	ECUV1H103ZFX	S.M. CAP	50V	10nF
C2135	ECA1HM101GB	ELECT	50V	100µF
C2136	ECJ2VF1H104Z	ELECT	350V	100nF
C2137	ECA1CM100GB	ELECT	16V	10µF
C2138	ECUV1H471KBX	S.M. CAP	50V	470pF
C2139	ECUV1H221JCX	S.M. CAP	50V	220pF
C2140	ECA1HM101GB	ELECT	50V	100µF
C2141	ECUV1H152JCX	S.M. CAP	50V	1.5pF
C2301	ECUV1H222JCX	S.M. CAP	50V	2.2nF
C2302	ECA1CM470GB	ELECT	16V	47µF
C2303	ECUV1H222JCX	S.M. CAP	50V	2.2nF
C2304	ECA1CM470GB	ELECT	16V	47µF
C3001	ECUV1H222JCX	S.M. CAP	50V	2.2nF
C3002	ECUV1H222JCX	S.M. CAP	50V	2.2nF
C3003	ECA1CM470GB	ELECT	16V	47µF
C3005	ECUV1H561JCX	S.M. CAP	50V	560pF
C3006	ECJ3VB1C474K	ELECT	3.5KV	470nF
C3007	ECUV1H222JCX	S.M. CAP	50V	2.2nF
C3008	ECUV1H222JCX	S.M. CAP	50V	2.2nF
C3009	ECUV1H222JCX	S.M. CAP	50V	2.2nF
C3010	ECA1CM470GB	ELECT	16V	47µF
C3012	ECUV1H561JCX	S.M. CAP	50V	560pF
C3013	ECJ3VB1C474K	ELECT	3.5KV	470nF
C3014	ECUV1H222JCX	S.M. CAP	50V	2.2nF
C3015	ECUV1H222JCX	S.M. CAP	50V	2.2nF
C3016	ECUV1H222JCX	S.M. CAP	50V	2.2nF
C3017	ECA1CM470GB	ELECT	16V	47µF
C3019	ECUV1H561JCX	S.M. CAP	50V	560pF
C3020	ECJ3VB1C474K	ELECT	3.5KV	470nF
C3021	ECUV1H222JCX	S.M. CAP	50V	2.2nF
C3022	ECUV1H222JCX	S.M. CAP	50V	2.2nF
C3023	ECUV1H222JCX	S.M. CAP	50V	2.2nF
C3024	ECA1CM470GB	ELECT	16V	47µF
C3026	ECUV1H561JCX	S.M. CAP	50V	560pF
C3027	ECJ3VB1C474K	ELECT	3.5KV	470nF
C3028	ECUV1H222JCX	S.M. CAP	50V	2.2nF
C3029	ECA1HM101GB	ELECT	50V	100µF
C3032	ECUV1H271JCX	S.M. CAP	50V	270pF
C3033	ECUV1H271JCX	S.M. CAP	50V	270pF
C3034	ECUV1H271JCX	S.M. CAP	50V	270pF
C3035	ECUV1H271JCX	S.M. CAP	50V	270pF
C3101	ECUV1H104KBX	S.M. CAP	50V	100nF
C3102	ECUV1E104KBX	S.M. CAP	25V	100nF
C3111	ECUV1H222KBX	S.M. CAP	50V	2.2nF
C3112	ECUV1H271JCX	S.M. CAP	50V	270pF
C3201	ECUV1H103KBX	S.M. CAP	50V	10nF
C3202	ECUV1H103KBX	S.M. CAP	50V	10nF
C3203	ECUV1H561JCX	S.M. CAP	50V	560pF
C3204	ECUV1H561JCX	S.M. CAP	50V	560pF
C3205	ECA1HM470GB	ELECT	50V	47µF
C3206	ECUV1H561JCX	S.M. CAP	50V	560pF
C3207	ECUV1H561JCX	S.M. CAP	50V	560pF
C3208	ECA1HM470GB	ELECT	50V	47µF
C3209	ECUV1H103KBX	S.M. CAP	50V	10nF
C3210	ECJ2VB1C104K	ELECT	350V	100nF
C3211	ECUV1H103KBX	S.M. CAP	50V	10nF
C3212	ECUV1H103KBX	S.M. CAP	50V	10nF
C3213	ECUV1H103KBX	S.M. CAP	50V	10nF
C3214	ECJ2VB1C104K	ELECT	350V	100nF
C3215	ECUV1H103KBX	S.M. CAP	50V	10nF
C3216	ECA1CM330GB	ELECT	16V	33pF
C3217	ECJ2VB1C104K	ELECT	350V	100nF



Cct Ref	Parts Number	Description		
C3221	ECA1HM4R7GB	ELECT	50V	4.7µF
C3401	ECQM1H224J	FILM	50V	220nF
C3402	ECUV1H101JCX	S.M. CAP	50V	100pF
C3403	ECA1HM101GB	ELECT	50V	100µF
C3404	ECQM1H224J	FILM	50V	220nF
C3405	ECUV1H180JCX	S.M. CAP	50V	18pF
C3406	ECUV1H271JCX	S.M. CAP	50V	270pF
C3407	ECUV1H271JCX	S.M. CAP	50V	270pF
C3408	ECA1HM101GB	ELECT	50V	100µF
C3601	ECA1HM101GB	ELECT	50V	100µF
JSE28	ECUV1H104KBX	S.M. CAP	50V	100nF
TERMINALS AND LINKS				
JK2301	JPJ841101320	RCA / HEADPHONE JACK		
JK3201	TJB16656	A.V. TERMINAL		
SWITCHES				
S802	ESB92S11B	SWITCH		
S1251	EVQ23405R	SWITCH		
S1252	EVQ23405R	SWITCH		
S1253	EVQ23405R	SWITCH		
S1254	EVQ23405R	SWITCH		
S1255	EVQ23405R	SWITCH		



SCHEMA ELETTRICO TX-W32R4F (TELAIO EURO-4)

IMPORTANTI INFORMAZIONI DI SICUREZZA

I componenti indicati con  hanno caratteristiche speciali ed importante per la sicurezza. Qualora tali componenti vengano sostituiti, devono essere usati solo quelli specificati dal costruttore.

Nota

- RESISTENZE**
Tutte le resistenze sono al carbone da 1/8W se sono contrassegnate come segue :
I valori sono espressi in OHM Ω k=1,000 M= 1,000,000.
- CONDENSATORI**
Tutti i condensatori sono ceramici 50V, se non sono contrassegnati come segue :
I valori sono espressi in μ F, se non diversamente specificato.
- BOBINE**
I valori sono espressi in μ H, se non diversamente specificato.
Il contrassegno "L" sullo schema elettrico indica la polarità.
- TEST POINT**
 Posizione dei test point
- MASSA**
 Massa Linea (Caldo)
 Massa Telaio (Freddo)
- CONTROLLI DI TENSIONE**
Le tensioni sono misurate con voltmetro d.c. alle seguenti condizioni :

Alimentazione	a.c. 220-240V, 50Hz
Segnale ricevuto	Segnale a barre colori in (RF)
Controlli dell'utente	Massime regolazioni
- Indica il flusso di segnale principale.
 VIDEO
 AUDIO
- Questo schema elettrico è soggetto a variazioni senza preavviso.

Precauzioni

- Nell'intento di prevenire possibili scosse elettriche evitare di toccare le zone fredde e calde.
- Un corto circuito fra le due sezioni può provocare anomalie nei componenti.
- Nell'utilizzo di uno strumento di misura la massa dello stesso deve essere collegata alla massa del circuito da misurare.
- Le resistenze sotto indicate sono componenti fusibili di sicurezza, e risultano differenziati per valori di corrente.

Nota

- 1) Nel circuito di alimentazione è presente una sezione le cui tensioni risultano separate dalla massa generale del telaio. Sullo schema elettrico vengono definite aree calda e fredda. Prestare particolare attenzione. Tutti i circuiti escluso quello di alimentazione sono freddi.

M BOARD
TNP8EM017

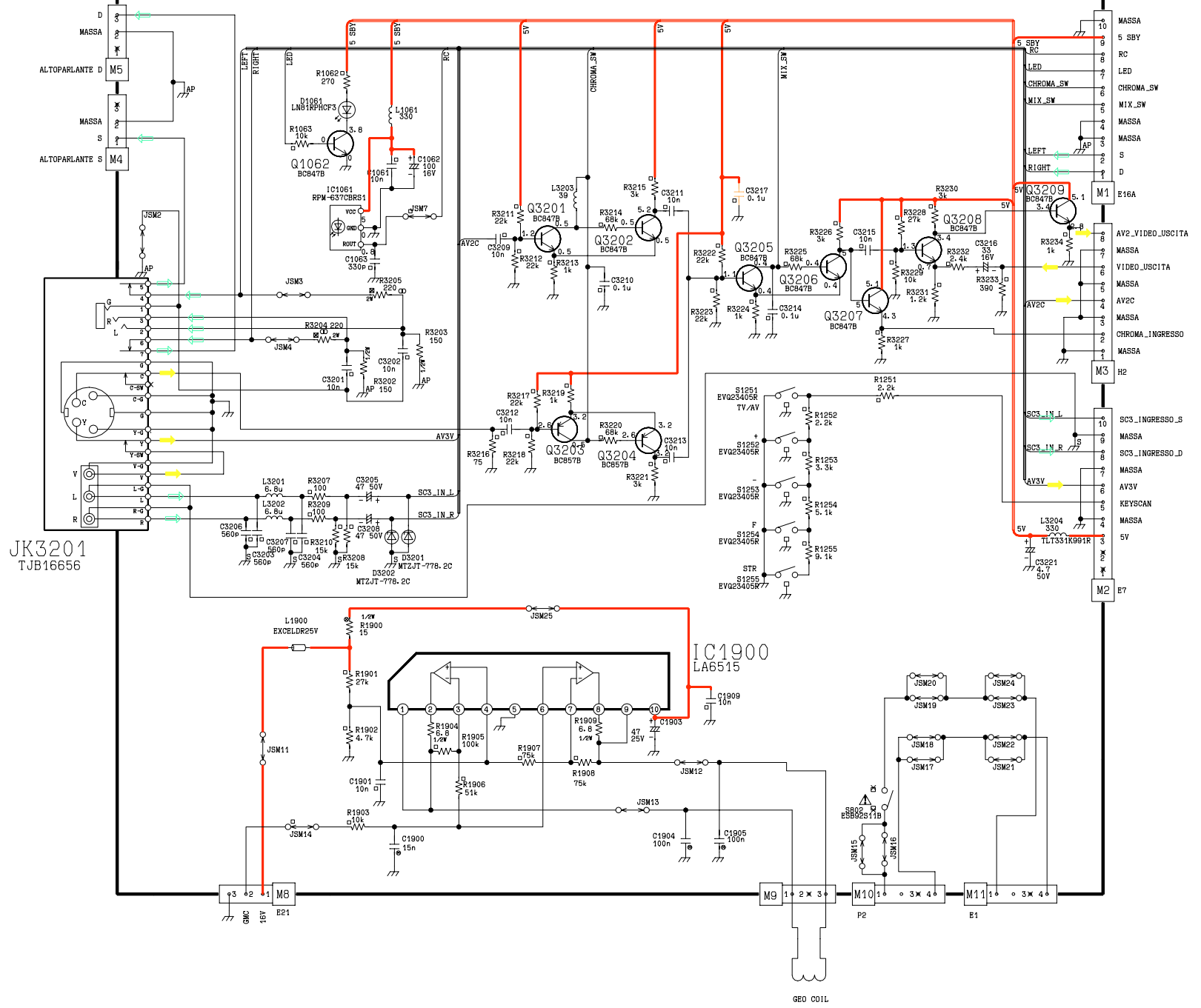

JK3201
TJB16656

GEO COIL

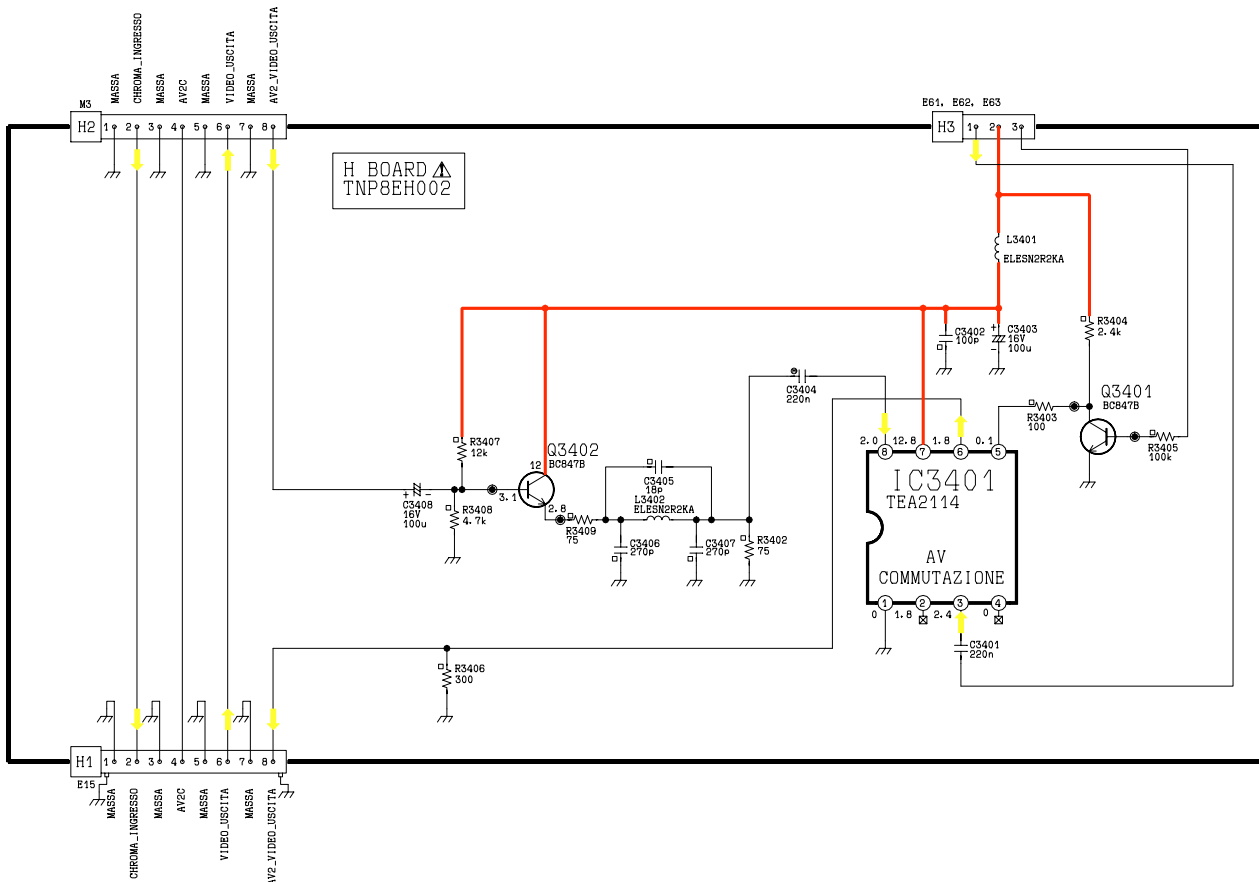

P BOARD
TNP8EP015

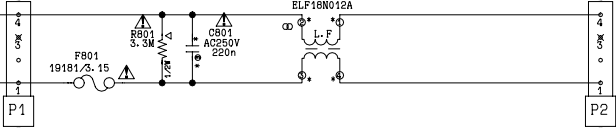
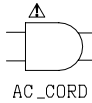

DY

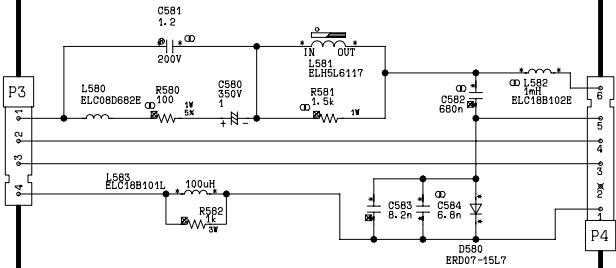

M10

E4

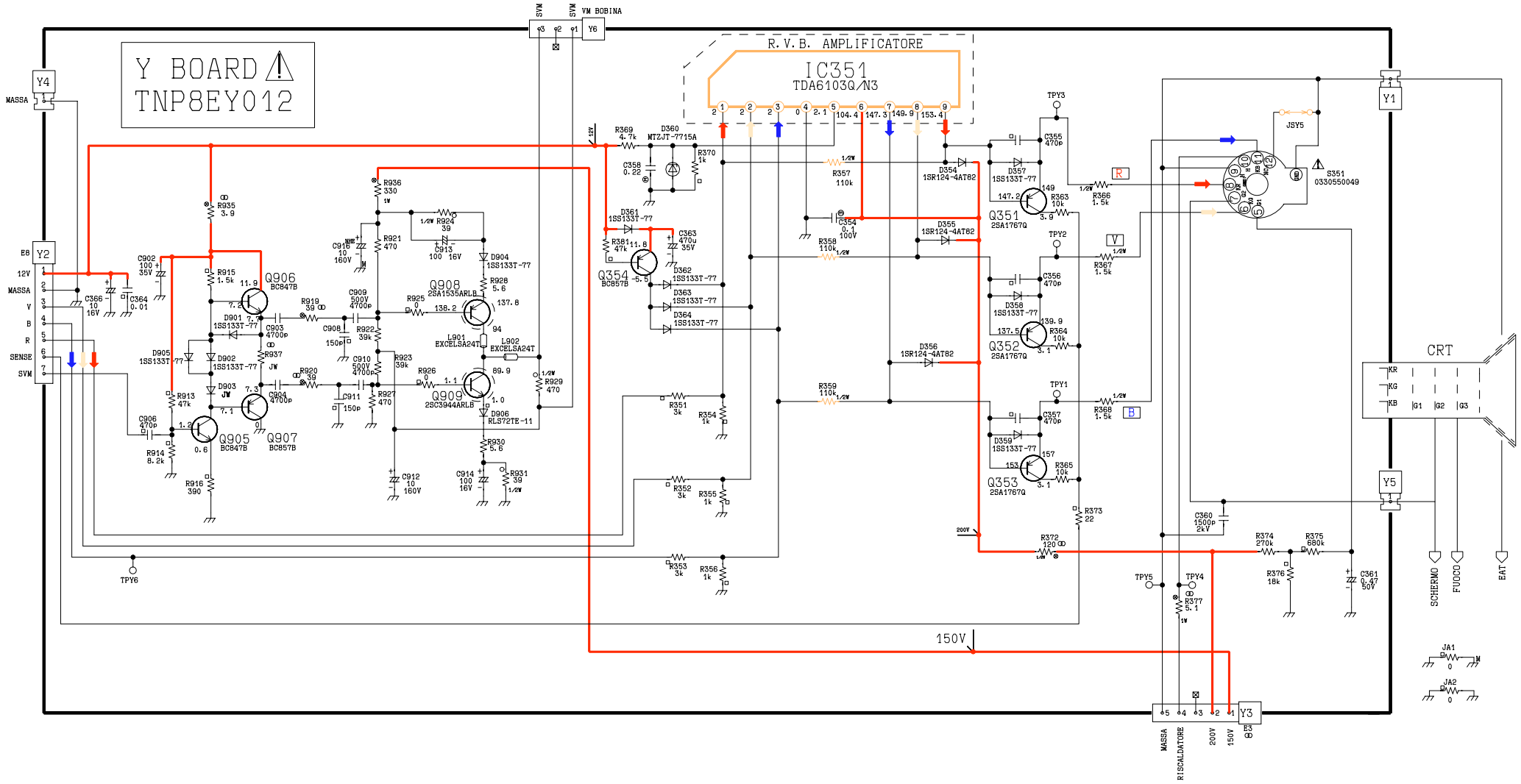

Y BOARD
TNP8EY012

R. V. B. AMPLIFICATORE
IC351
TDA6103Q/N3

CRT
KR
KG
KB
g1 g2 g3

SCHEMIO
FUOCO
EAT

MASSA
RISCALDATORE
200V
150V
B3

Y4
MASSA
Y2
12V
MASSA
V
B
R
SENSE
SVM

SVM
VM BOBINA
Y6

Y1

S351
0330550049

150V

TPY5

TPY4

TPY3

TPY2

TPY1

R355

R354

R353

R352

R351

Y5

R375

R374

C361

150V

200V

MASSA

Y3

B3

B

R368

R367

1.5k

1.2W

1.2W

1.2W

1.2W

1.2W

1.2W

1.2W

1.2W

1.2W

1.2W

1.2W

1.2W

1.2W

1.2W

1.2W

1.2W

1.2W

1.2W

1.2W

1.2W

1.2W

1.2W

1.2W

1.2W

1.2W

1.2W

1.2W

1.2W

1.2W

1.2W

1.2W

1.2W

1.2W

1.2W

1.2W

1.2W

1.2W

E BOARD
TNP8EE009

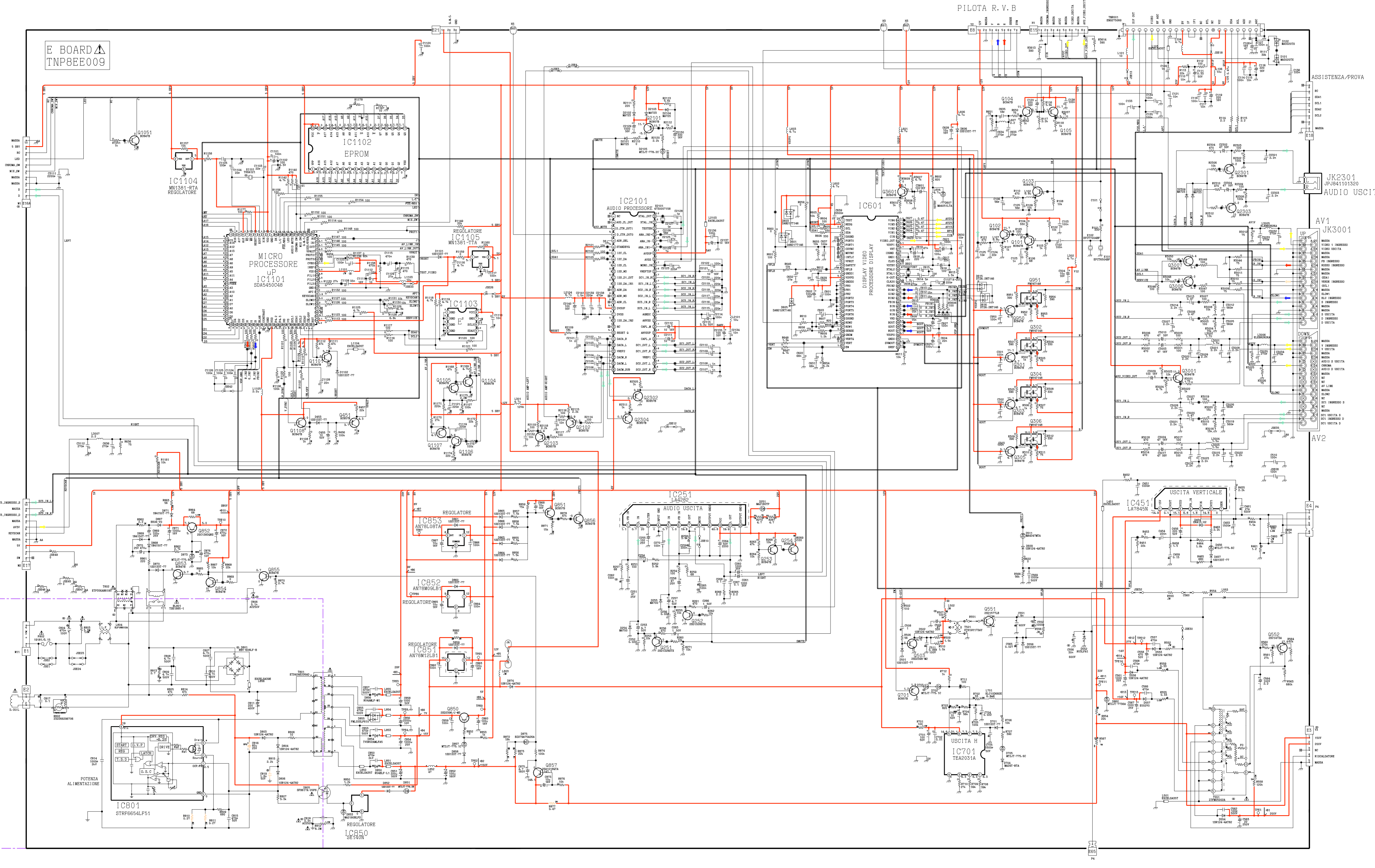

ASSISTENZA/PROVA

JK2301
UPJ841101320
AUDIO USCITA

AV1
JK3001

AV2

IC451
LA7845N
USCITA VERTICALE

USCITA H
IC701
TEA2031A

AV3

AV4

AV5

AV6

AV7

AV8

AV9

AV10

AV11

AV12

AV13

AV14

AV15

AV16

AV17

AV18

AV19

AV20

AV21

AV22

AV23

AV24

AV25

AV26

AV27

AV28

AV29

AV30

AV31

AV32

AV33

AV34

AV35

AV36

AV37

AV38

AV39

AV40

AV41

AV42

AV43

AV44

AV45

AV46

AV47

AV48

AV49

AV50

AV51

AV52

AV53

AV54

AV55

AV56

AV57

AV58

AV59

AV60

AV61

AV62

AV63

AV64

AV65

AV66

AV67

AV68

AV69

AV70

AV71

AV72

AV73

AV74

AV75

AV76

AV77

AV78

AV79

AV80

AV81

AV82

AV83

AV84

AV85

AV86

AV87

AV88

AV89

AV90

AV91

AV92

AV93

AV94

AV95

AV96

AV97

AV98

AV99

AV100

AV101

AV102

AV103

AV104

AV105

AV106

AV107

AV108

AV109

AV110

AV111

AV112

AV113

AV114

AV115

AV116

AV117

AV118

AV119

AV120

AV121

AV122

AV123

AV124

AV125

AV126

AV127

AV128

AV129

AV130

AV131

AV132

AV133

AV134

AV135

AV136

AV137

AV138

AV139

AV140

AV141

AV142

AV143

AV144

AV145

AV146

AV147

AV148

AV149

AV150

AV151

AV152

AV153

AV154

AV155

AV156

AV157

AV158

AV159

AV160

AV161

AV162

AV163

AV164

AV165

AV166

AV167

AV168

AV169

AV170

AV171

AV172

AV173

AV174

AV175

AV176

AV177

AV178

AV179

AV180

AV181

AV182

AV183

AV184

AV185

AV186

AV187

AV188

AV189

AV190

AV191

AV192

AV193

AV194

AV195

AV196

AV197

AV198

AV199

AV200

AV201

AV202

AV203

AV204

AV205

AV206

AV207

AV208

AV209

AV210

AV211

AV212

AV213

AV214

AV215

AV216

AV217

AV218

AV219

AV220

AV221

AV222

AV223

AV224

AV225

AV226

AV227

AV228

AV229

AV230

AV231

AV232

AV233

AV234

AV235

AV236

AV237

AV238

AV239

AV240

AV241

AV242

AV243

AV244

AV245

AV246

AV247

AV248

AV249

AV250

AV251

AV252

AV253

AV254

AV255

AV256

AV257

AV258

AV259

AV260

AV261

AV262

AV263

AV264

AV265

AV266

AV267

AV268

AV269

AV270

AV271

AV272

AV273

AV274

AV275

AV276

AV277

AV278

AV279

AV280

AV281

AV282

AV283

AV284

AV285

AV286

AV287

AV288

SCHEDA - E TNP8EE009

TRAN'S	DIODES	D558 L4
Q3601 L8	D3103 B7	D557 M4
Q3007 M9	D3101 B7	D556 K1
Q3001 N8	D3102 B7	D555 N3
Q3006 N10	D2161 G9	D554 M4
Q2304 I7	D2105 G10	D553 K4
Q2303 M6	D2104 F9	D552 J2
Q2301 I7	D2103 G10	D551 K3
Q2103 I8	D2102 G9	D511 M5
Q2102 H8	D1103 F8	D502 I2
Q2101 G10	D1102 F7	D501 I2
Q1108 F9	D1101 G7	D457 L5
Q1107 C7	D1051 A9	D456 L5
Q1106 C7	D875 J5	D454 L5
Q1105 C7	D874 J4	D453 F9
Q1104 C7	D873 B5	D254 C5
Q1101 F7	D871 A5	D253 C5
Q1052 A9	D870 871	D252 B5
Q1051 C8	D869 B4	D251 B4
Q951 J9	D868 B4	IC'S
Q950 J9	D867 A3	IC2101 H8
Q857 J4	D866 I9	IC1105 F7
Q856 F9	D865 I9	IC1104 C9
Q855 J5	D864 I10	IC1103 F8
Q854 B4	D863 G9	IC1102 D10
Q853 B4	D862 N10	IC1101 D8
Q852 B5	D861 J9	IC1051 A10
Q850 F5	D860 I10	IC852 I10
Q701 J5	D859 H5	IC851 G5
Q552 N3	D858 E5	IC850 H4
Q551 K1	D857 E5	IC801 G2
Q503 I2	D855 F4	IC701 K5
Q451 F8	D854 G4	IC601 L7
Q394 K9	D853 H3	IC451 L5
Q305 K9	D852 I4	IC251 D6
Q303 K9	D851 I4	TP'S
Q302 J9	D850 H4	TPE14 M5
Q301 K9	D806 G2	TPE13 M4
Q253 C4	D805 H2	TPE12 K4
Q252 C4	D804 H1	TPE11 N5
Q252 C4	D803 H1	TPE10 B5
Q251 D4	D802 G2	TPE9 E5
Q105 M8	D801 E1	TPE8 F5
Q104 M9	D705 J5	TPE7 I9
Q103 F10	D704 K5	TPE6 J10
Q102 G10	D703 K5	TPE5 G5
Q101 H10	D702 K5	TPE4 G5
	D701 K5	TPE3 E5
	D609 M5	TPE2 I5
	D607 L9	TPE1 M4

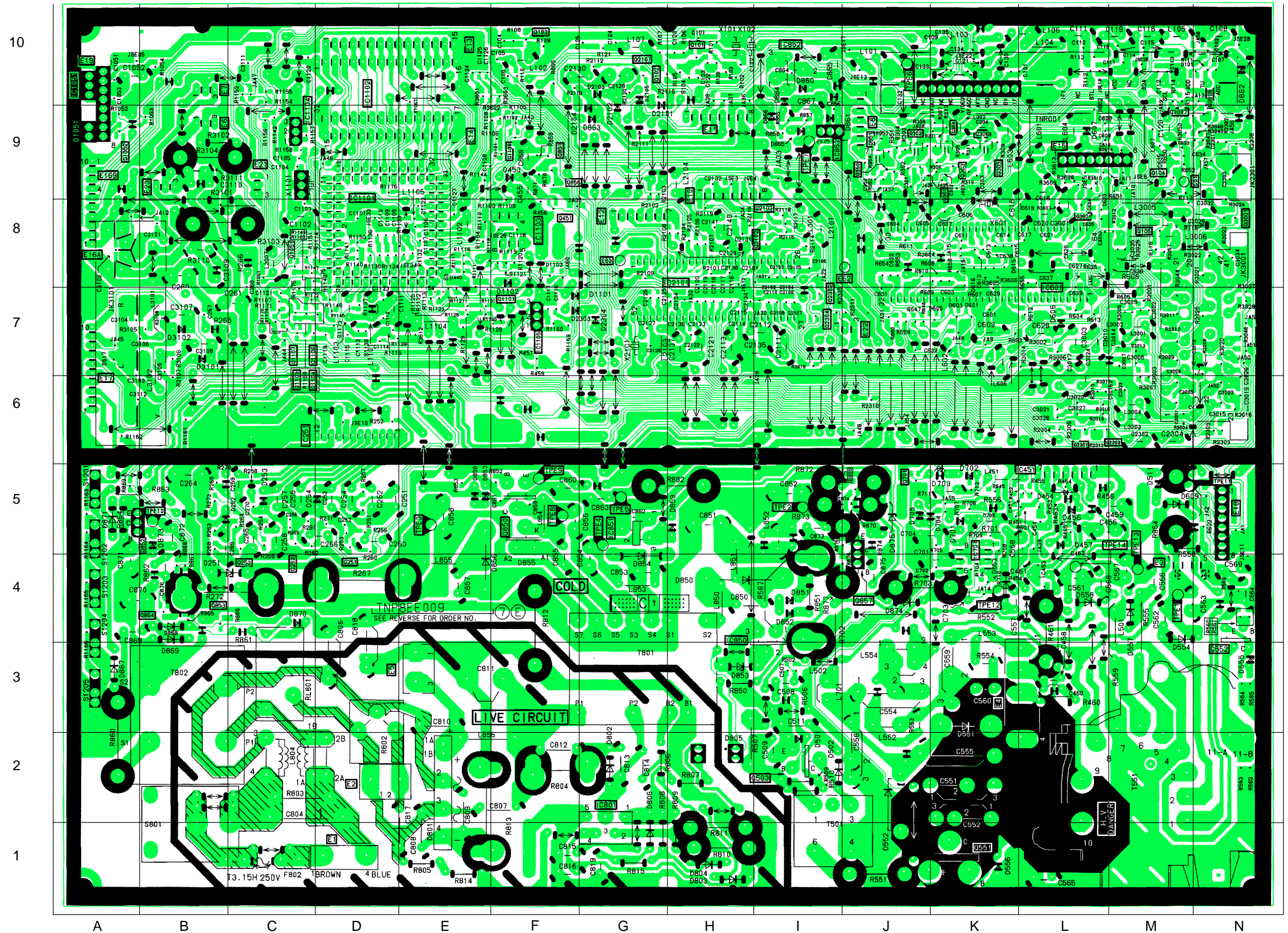

SCHEDA - Y TNP8EY012

TRANSISTORS	
Q909	E1
Q908	C2
Q907	F4
Q906	G3
Q905	F5
Q354	A7
Q353	G6
Q352	F6
Q351	F6
DIODES	
D906	F1
D905	G4
D904	D3
D902	G4
D901	G3
D364	C9
D363	C8
D362	B9
D361	B7
D360	D8
D359	G6
D358	E7
D357	F7
D356	G7
D355	F7
D354	G7
TEST POINTS	
TPY6	B8
TPY5	D5
TPY4	E5
TPY3	F6
TPY2	E7
TPY1	G6
IC'S	
IC351	E8

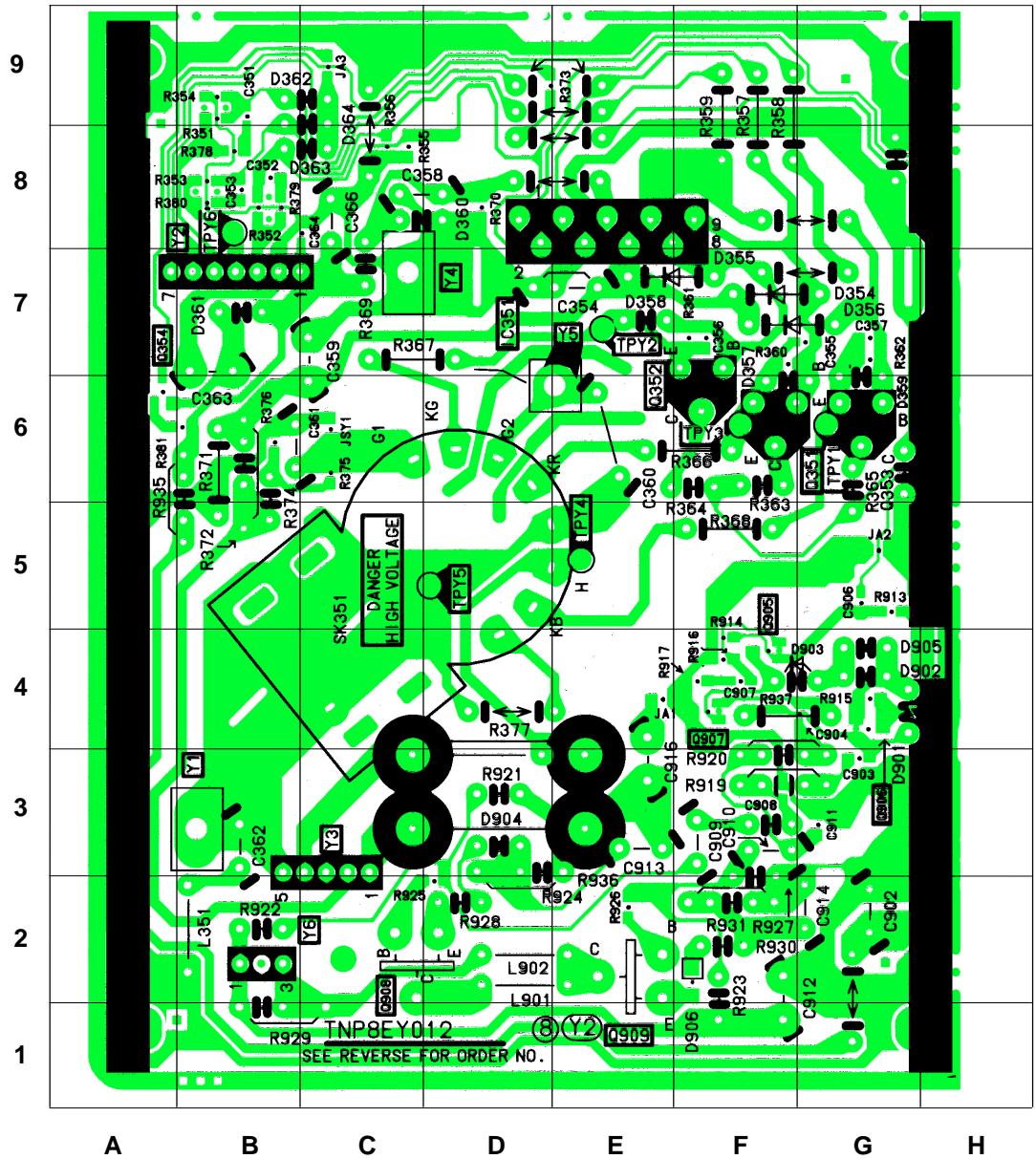

SCHEDA - M TNP8EM017

TRANSISTORS	
Q3201	B10
Q3202	B9
Q3203	B9
Q3204	B9
Q3205	C1
Q3206	D2
Q3207	C2
Q3208	C3
Q3209	C3
Q1900	D10
Q1061	B10
Q1062	A10
DIODES	
D3201	C10
D3202	C10
D3203	B11
D1900	D8
D1061	A11
IC'S	
IC1900	D9
IC1901	D8
IC1061	A10

